

## MEASUREMENT-

Measurement of a quantity is the result of comparison of quantity's whose magnitude is unknown with a predefined standard. Measurement is the process by which we convert physical parameter to meaningful no.

Methods of Measurement-

1) Direct Method

2) Indirect Method

1) Direct Method –

In this method, the unknown quantity is directly compared against a standard. The result is expressed as a numerical no. and a unit. This type of method is mostly common for the measurements of physical quantities. These physical quantities include length, mass and time.

For example - We want to measure the length of a rod. Unit of length is in meter.

Indirect Method - measurement by direct VB method are not always possible feasible and practicable. These methods are inaccurate. Hence direct methods are not preferred and are barely used in daily life.

In Indirect method we use an instrument which is called transducer. This instrument is very useful for indirect measurement because transducer element convert the physical quantity in an analogous form.

\* Basic Measurement system –

A measuring system exists to provide information about the physical value of some variable being measured. In simple cases the system can consist of only output reading or signal according to the magnitude of the unknown variable applied to it.

1) Measured –

It is the quantity which is to be measured by measurement system this is first sensed by the primary sensing element whose type depends upon the type of quantity to be measured.

2) Primary sensing element –

The first contact of the measured in the measurement system is with the primary sensing element, which is basically a transducer. It converts measured to its corresponding electrical signal which is further processed in subsequent stages.

3) Variable conversion element –

The output of the primary sensing element is the electrical signal which is of no use as such in measurement system. So, this electrical signal needs to be converted into a suitable form as per the requirement of the system without distributing the original content or information of the signal.

4) Variable Manipulation element –

As the name suggest, the functions of V.M.F is to manipulate the signal presented to it preserving the original nature of the signal. Manipulation means there is change only in the numerical value of the signal.

5) Data transmission element –

When the element of an instrument is actually physical separated it becomes necessary to transmit data from one to another. The element that performs this function is called data transmission element.

#### 6) Data Presentation Element –

As the name suggests, this element is used to present or display the data. We know that the information about the measurand has to be conveyed to the personal handling or the system for monitoring control or analysis purposes. The information conveyed must be in form intelligible to personal or to the intelligent instrumentation system. The function is done by data presentation element.

#### \* Display Device:-

The final stage of a measurement system is the data presentation stage consisting of data presentation element. This stage consists of display device. It can be classified as:-

##### 1) Analog Instrument Display Device :-

Analog display device comprise of indicating instruments which directly indicate the quantity to be measured on the scale in form of pointer deflection.

##### 2) Digital Instrument Display Devices :-

Digital display device directly display the result on the screen. A digital display device may receive digital information in any form but it converts that information to the decimal form.

#### Seven Segment Display Devices: -

This is used for numeric display consisting of seven segment a,b, c,d,e,f,g.

## Transducers

A device which converts a physical quantity into the proportional electrical signal is called a transducer. The electrical signal produced may be a voltage, current or frequency. A transducer uses many effects to produce such conversion. The process of transforming signal from one form to other is called transduction. A transducer is also called pick up. The transduction element transforms the output of the sensor to an electrical output, as shown in the Fig.

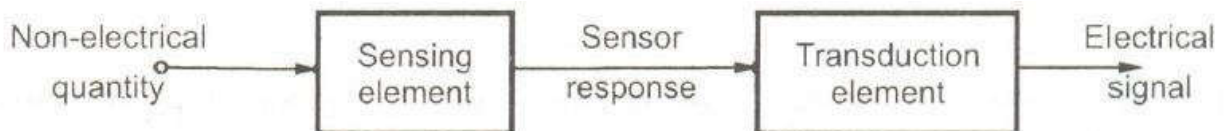

A transducer will have basically two main components. They are

### 1. Sensing Element

The physical quantity or its rate of change is sensed and responded to by this part of the transducer.

### 2. Transduction Element

The output of the sensing element is passed on to the transduction element. This element is responsible for converting the non-electrical signal into its proportional electrical signal.

There may be cases when the transduction element performs the action of both transduction and sensing. The best example of such a transducer is a thermocouple. A thermocouple is used to generate a voltage corresponding to the heat that is generated at the junction of two dissimilar metals.

**Electrical transducers: -**

Electrical quantities are measured by electrical measurement. In order to measure non- electrical quantities, a detector i.e. sensing element is used which normally converts the physical quantities into a displacement. This displacement actuates electrical transducers which gives output which is electrical in nature.

**PARAMETER OF ELECTRICAL TRANSDUCERS:-**

1. The weight and volume of transducer should be as low as possible so that its presence does not disturb the existing condition in measurement system.
2. The transducer should be highly sensitive.
3. The output of the transducers should be compatible with the input of the measuring system.
4. Operating range of the transducers should be avoid so that it can we used under a wide range of measurement.
5. The relationship of the input and the output of the transducers can be linear.

**ADVANTAGES OF ELECTRICAL TRANSDUCERS:-**

1. The effect of friction is minimized.
2. Mass inertia effects are minimized.
3. The electrical / electronic system can be controlled with a small power.
4. Modern Digital computers make the use of these transducers absolutely essential.

**CLASSIFICATION OF TRANSDUCERS:-**

The Classification of Transducers is done in many ways. Some of the criteria for the classification are based on their area of application, Method of energy conversion, Nature of output signal, According to Electrical principles involved, Electrical parameter used, principle of operation, & Typical applications.

1. As passive and active transducers
2. As analog and digital transducers
3. As transducers and inverse transducers

**PASSIVE AND ACTIVE TRANSDUCER:-**

Passive transducers are those that take the power for transduction from an externally power source. They also derive parts of the power required for conversion from the physical quantity under measurement. Passive transducers are also known as externally powered transducers.

**ACTIVE TRANSDUCERS:-**

These are the transducers that do not require an auxiliary power source to produce their output. They develop their own voltage or current outputs, thus they are also known as self generating type. The energy required to produce output signal is obtained from the physical quantity being measured.

## **ANALOG AND DIGITAL TRANSDUCERS:-**

### **ANALOG TRANSDUCERS:-**

These transducers convert the input quantity into an analog output which is a continuous function of time. A strain gauge, a thermocouple, thermostat are all examples of analog transducers as they give an output which is a continuous function of time.

### **DIGITAL TRANSDUCERS:-**

These transducers convert the input quantity into an electrical output which is in the form of pulse.

## **TRANSDUCERS AND INVERSE**

### **TRANSDUCERS:- TRANSDUCERS:-**

Transducers are a device that transforms non-electrical quantity into an electrical quantity.

### **INVERSE TRANSDUCERS:-**

As the name suggests, it performs the reverse function of transducers. This device converts an electrical into a non-electrical quantity. A current-carrying coil moving in a magnetic field is an inverse transducer. It becomes current-carrying by it is converted into force which causes translation or rotational displacement.

### **On the basis of Transduction Principle used:**

**Resistive Transducers:** - The transducer whose resistance varies because of the environmental effect is called resistance transducers.

#### **Resistive Transducers**

1. Resistance Strain Gauge – The change in value of resistance of metal semi-conductor due to elongation or compression is known by the measurement of torque, displacement or force.
2. Resistance Thermometer – The change in resistance of metal wire due to the change in temperature known by the measurement of temperature.
3. Resistance Hygrometer – The change in the resistance of conductive strip due to the change of moisture content is known by the value of its corresponding humidity.
4. Hot Wire Meter – The change in resistance of a heating element due to convection cooling of a flow of gas is known by its corresponding gas flow or pressure.
5. Photoconductive Cell – The change in resistance of a cell due to a corresponding change in light flux is known by its corresponding light intensity.
6. Thermistor – The change in resistance of a semi-conductor that has a negative co-efficient of resistance is known by its corresponding measure of temperature.
7. Potentiometer Type – The change in resistance of a potentiometer reading due to the movement of the slider as a part of an external force applied is known by its corresponding pressure or displacement.

#### **Capacitance Transducers**

1. Variable capacitance pressure gage -

Principle of operation: Distance between two parallel plates is varied by an externally applied force  
Applications: Measurement of Displacement, pressure

2. Capacitor microphone

Principle of operation: Sound pressure varies the capacitance between a fixed plate and a movable diaphragm. Applications: Speech, music, noise

### 3. Dielectric gauge

Principle of operation: Variation in capacitance by changes in the dielectric. Applications: Liquid level, thickness

## Inductance Transducers

1. Magnetic circuit transducer  
Principle of operation: Self inductance or mutual inductance of ac-excited coil is varied by changes in the magnetic circuit. Applications: Pressure, displacement
2. Reluctance pickup  
Principle of operation: Reluctance of the magnetic circuit is varied by changing the position of the iron core of a coil. Applications: Pressure, displacement, vibration, position
3. Differential transformer  
Principle of operation: The differential voltage of two secondary windings of a transformer is varied by positioning the magnetic core through an externally applied force. Applications: Pressure, force, displacement, position
4. Eddy current gage  
Principle of operation: Inductance of a coil is varied by the proximity of an eddy current plate. Applications: Displacement, thickness
5. Magnetostriction gauge  
Principle of operation: Magnetic properties are varied by pressure and stress. Applications: Force, pressure, sound

## Voltage and current Transducers

1. Hall effect pickup  
Principle of operation: A potential difference is generated across a semiconductor plate (germanium) when magnetic flux interacts with an applied current. Applications: Magnetic flux, current
2. Ionization chamber  
Principle of operation: Electron flow induced by ionization of gas due to radioactive radiation. Applications: Particle counting, radiation
3. Photoemissive cell  
Principle of operation: Electron emission due to incident radiation on photoemissive surface. Applications: Light and radiation
4. Photomultiplier tube  
Principle of operation: Secondary electron emission due to incident radiation on photosensitive cathode. Applications: Light and radiation, photo-sensitive relays

## FACTOR AFFECTING THE CHOICE OF THE TRANSDUCER÷

Some of the factor which determine the choice of transducer are as follow ÷

1. Linearity the input & output characteristics of the transducers should be linear.
2. Sensitivity ÷  
The transducer must be sensitive enough to produce detectable output.
3. Accuracy÷  
High degree of accuracy is assured if the transducers do not require frequent calibration and has a small value of repeatability.
4. Intensity to unwanted signal ÷

The transducer should be minimally sensitive to unwanted signal.

#### 5. Loading effects:-

The output impedance should be high and input impedance should be low of the transducers to avoid the loading effect.

#### 6. Errors:-

The transducer should be maintaining the input – output relationship as described by its transfer function so as to avoid errors.

#### 7. Electrical Aspects:-

While selecting a transducer the electrical aspects such as length, type of cable required should be considered. Signal noise ratio, frequency response limitations must also be taken into account.

#### 8. Operating principle: -

The transducer must be selected on the basis of operating principle used may resistive, inductive, capacitor, piezoelectric etc.

#### 9. Repeatability: -

Accurate transducers are capable of producing the same result again and again under same environmental conditions e.g. – temperature pressure, humidity etc.

#### 10. Residual Deformation: -

There should be no deformation of the testing material after the removal of any pressure after long period of application.

#### 11. Stability: -

High degree of stability is shown by transducer during its operation.

### **Requirements of a good transducers**

- Smaller in size and weight.
- High sensitivity.
- Ability to withstand environmental conditions.
- Low cost.

## RESISTIVE TRANSDUSERS

Resistance of an electrical conductor is given by,

$$R = \rho l / A$$

Where ,

R = Resistance in „Ω“

P = Resistivity of the conductor (Ω - cm)

l = Length of the conductor in cm.

A = Cross-sectional area of the metal conductor in cm<sup>2</sup>

It is clear from the equation that, the electrical resistance can be varied by varying,

(i) Length

(ii) Cross-sectional area and

(iii) Resistivity or combination of these.

### Principle:-

A change in resistance of a circuit due to the displacement of an object is the measure of displacement of that object ,method of changing the resistance and the resulting devices are summarized in the following

Method of changing resistance-

Length - Resistance can be changed varying the length of the conductor,(linear and rotary).

Dimensions - When a metal conductor is subjected to mechanical strain, change in dimensions of the conductor occurs, that changes the resistance of the conductor.

Resistivity -

When a metal conductor is subjected to a change in temperature and change in resistivity occurs which changes resistance of the conductor.

Resulting device:-

Resistance potentiometers or sliding contact devices displacements ,Electrical resistance strain gauges. Thermistor and RTD

### Use:-

the resistive transducer used for the measurement of linear and angular, and used for the temperature mechanical strain measurement.

### How Potentiometer works

A potentiometer is a resistive sensor used to measure linear displacements as well as rotary motion. In a potentiometer an electrically conductive wiper slides across a fixed resistive element. A voltage is applied across the resistive element. Thus a voltage divider circuit is formed. The output voltage ( $V_{out}$ ) is measured as shown in the figure below. The output voltage is proportional to the distance travelled.

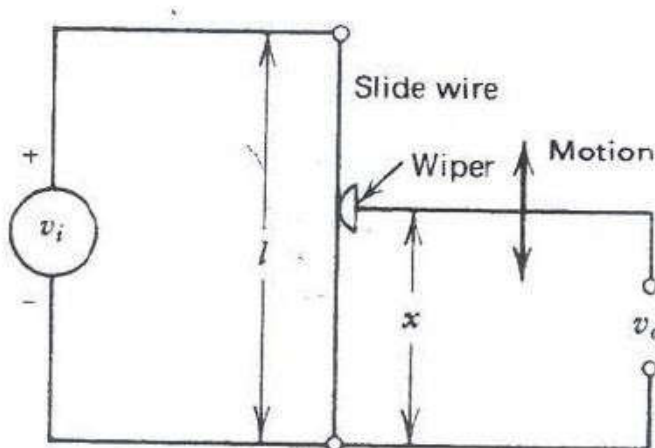

There are two types of potentiometer, linear and rotary potentiometer. The linear potentiometer has a slide or wiper. The rotary potentiometer can be a single turn or multi turn.

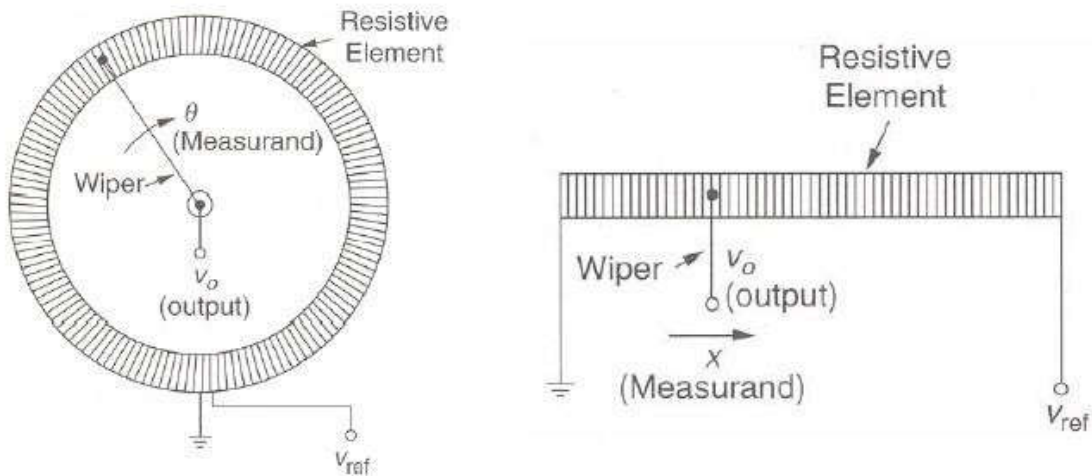

### The important parameters while selecting a potentiometer are

- Operating temperature
- Shock and vibration
- Humidity
- Contamination and seals
- life cycle
- dither



## Types of Potentiometer:

### Wire-Wound type potentiometer

- The resistance range between  $10\Omega$  and  $10M\Omega$
- The resistance increase in a stepwise manner.
- It is possible to construct potentiometers with 100 –200 turns per cm length (The resolution range between 0.1 to 0.05 mm).
- Linear potentiometers are available in many lengths up to 1m.
- Helical potentiometers are commercially available with 50 to 60 turns (The angular displacement is between 18000 – 21600 degree)
- Potentiometer life exceed 1 million cycles.

### Thin film type potentiometer

- Higher resolution.
- Lower noise.
- Longer life (exceed 10 million cycles)
- Resistance of 50 to 100  $\Omega$ /mm can be obtained with conductive plastic film.
- Commercially available resolution is 0.001 mm.

- Power rating

$$P = \frac{V_m^2}{R_p}$$

$$V_{m(\max)} = \sqrt{PR_p}$$

- Sensitivity

$$V_o = \frac{V_m}{L} x$$

$$\text{Sensitivity} = \frac{V_m}{L}$$

- Linearity 
$$V_o = V_m \left( \frac{R}{R_p} \right) \left[ \frac{R_M/R_p}{(R_M/R_p) + (R/R_p) - (R/R_p)^2} \right]$$

- Optimum sensitivity (0.2 V/degree and 2 V/cm)

### Some of the advantages of the potentiometer are

- Easy to use
- low cost
- High amplitude output
- Proven technology
- Easily available

### Some of the disadvantages of the potentiometer are

- Since the wiper is sliding across the resistive element there is a possibility of friction and wear. Hence the number of operating cycles are limited.
- Limited bandwidth
- Inertial loading

### Some of the applications of the potentiometer are

- Linear displacement measurement
- Rotary displacement measurement
- Volume control
- Brightness control
- Liquid level measurements using float

## Strain Gauge

Strain gage is one of the most popular types of transducer. It has got a wide range of applications. It can be used for measurement of force, torque, pressure, acceleration and many other parameters. The basic principle of operation of a strain gage is simple: when strain is applied to a thin metallic wire, its dimension changes, thus changing the resistance of the wire. Let us first investigate what are the factors, responsible for the change in resistance.

### Gage Factor

Let us consider a long straight metallic wire of length  $l$  circular cross section with diameter  $d$  (fig). When this wire is subjected to a force applied at the two ends, a strain will be generated and as a result, the dimension will change ( $l$  changing to  $l + \Delta l$ ,  $d$  changing to  $d + \Delta d$  and  $A$  changing to  $A + \Delta A$ ). For the time being, we are considering that all the changes are in positive direction. Now the resistance of the wire:

Let us consider a long straight metallic wire of length  $l$  circular cross section with diameter  $d$  (fig. 5). When this wire is subjected to a force applied at the two ends, a strain will be generated and as a result, the dimension will change ( $l$  changing to  $l + \Delta l$ ,  $d$  changing to  $d + \Delta d$  and  $A$  changing to  $A + \Delta A$ ). For the time being, we are considering that all the changes are in positive direction. Now the resistance of the wire:

$$R = \frac{\rho l}{A}, \text{ where } \rho \text{ is the resistivity.}$$

From the above expression, the change in resistance due to strain:

$$\begin{aligned} \Delta R &= \left( \frac{\partial R}{\partial l} \right) \Delta l + \left( \frac{\partial R}{\partial A} \right) \Delta A + \left( \frac{\partial R}{\partial \rho} \right) \Delta \rho \\ &= \frac{\rho}{A} \Delta l - \frac{\rho}{A^2} \Delta A + \frac{l}{A} \Delta \rho \\ &= R \frac{\Delta l}{l} - R \frac{\Delta A}{A} + R \frac{\Delta \rho}{\rho} \end{aligned}$$

or,

$$\frac{\Delta R}{R} = \frac{\Delta l}{l} - \frac{\Delta A}{A} + \frac{\Delta \rho}{\rho} \quad (6)$$

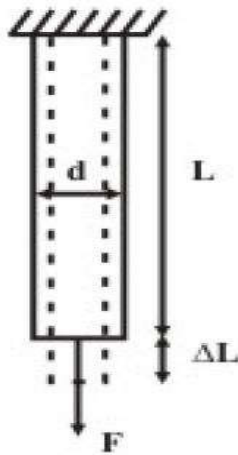

Fig:Change of Resistance with strain

Now, for a circular cross section,  $A = \frac{\pi d^2}{4}$ ; from which,  $\Delta A = \frac{\pi d}{2} \Delta d$ . Alternatively,

$$\frac{\Delta A}{A} = 2 \frac{\Delta d}{d}$$

Hence,

$$\frac{\Delta R}{R} = \frac{\Delta l}{l} - 2 \frac{\Delta d}{d} + \frac{\Delta \rho}{\rho} \quad (7)$$

Now, the *Poisson's Ratio* is defined as:

$$\nu = - \frac{\text{lateral strain}}{\text{longitudinal strain}} = - \frac{\Delta d/d}{\Delta l/l}$$

The Poisson's Ratio is the property of the material, and does not depend on the dimension. So,

(6) can be rewritten as:

$$\frac{\Delta R}{R} = (1 + 2\nu) \frac{\Delta l}{l} + \frac{\Delta \rho}{\rho}$$

Hence,

$$\frac{\Delta R/R}{\Delta l/l} = 1 + 2\nu + \frac{\Delta \rho/\rho}{\Delta l/l}$$

The last term in the right hand side of the above expression, represents the change in resistivity of the material due to applied strain that occurs due to the *piezo-resistance property* of the material. In fact, all the elements in the right hand side of the above equation are independent of the geometry of the wire, subjected to strain, but rather depend on the material property of the wire. Due to this reason, a term *Gage Factor* is used to characterize the performance of a strain gage. The Gage Factor is defined as:

$$G := \frac{\Delta R/R}{\Delta l/l} = 1 + 2\nu + \frac{\Delta \rho/\rho}{\Delta l/l} \quad (8)$$

For normal metals the Poisson's ratio  $\nu$  varies in the range:

$$0.3 \leq \nu \leq 0.6,$$

while the piezo-resistance coefficient varies in the range:

$$0.2 \leq \frac{\Delta \rho/\rho}{\Delta l/l} \leq 0.6.$$

Thus, the Gage Factor of metallic strain gages varies in the range 1.8 to 2.6. However, the semiconductor type strain gages have a very large Gage Factor, in the range of 100-150. This is attained due to dominant piezo-resistance property of semiconductors. The commercially available strain gages have certain fixed resistance values, such as, 120 $\Omega$ , 350  $\Omega$ , 1000  $\Omega$ , etc. The manufacturer also specifies the Gage Factor and the maximum gage current to avoid self-heating (normally in the range 15 mA to 100 mA).

The choice of material for a metallic strain gage should depend on several factors. The material should have low temperature coefficient of resistance. It should also have low coefficient for thermal expansion. Judging from all these factors, only few alloys qualify for a commercial metallic strain gage. They are:

*Advance* (55% Cu, 45% Ni): Gage Factor between 2.0 to 2.2

*Nichrome* (80% Ni, 20% Co): Gage Factor between 2.2 to 2.5

Apart from these two, *Isoelastic* -another trademarked alloy with Gage Factor around 3.5 is also in use. Semiconductor type strain gages, though having large Gage Factor, find limited use, because of their high sensitivity and nonlinear characteristics.

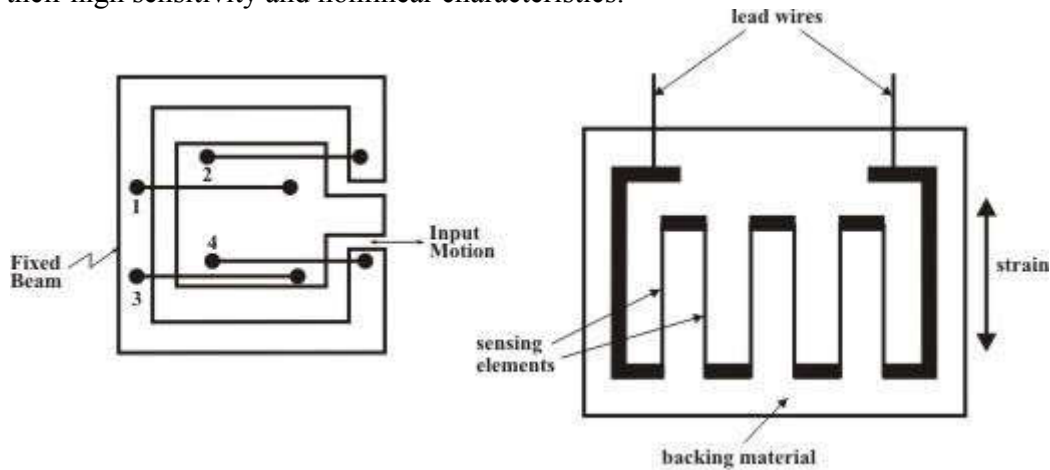

Fig. 6 (a) Unbonded metallic strain gage, (b) bonded metal foil type strain gage

### Metallic Strain Gage

Most of the strain gages are metallic type. They can be of two types: *unbonded* and *bonded*. The unbonded strain gage is normally used for measuring strain (or displacement) between a fixed and a moving structure by fixing four metallic wires in such a way, so that two are in compression and two are in tension, as shown in fig. 6 (a). On the other hand, in the bonded strain gage, the element is fixed on a backing material, which is permanently fixed over a structure, whose strain has to be measured, with adhesive. Most commonly used bonded strain gages are *metal foil type*. The construction of such a strain gage is shown in fig. 6(b). The metal foil type strain gage is manufactured by photo-etching technique. Here the thin strips of the foil are the active elements of the strain gage, while the thick ones are for providing electrical connections. Because of large area of the thick portion, their resistance is small and they do not contribute to any change in resistance due to strain, but increase the heat dissipation area. Also it is easier to connect the lead wires with the strain gage. The strain gage in fig. 6(b) can measure strain in one direction only. But if we want to measure the strain in two or more directions at the same point, strain gage *rosette*, which is manufactured by stacking multiple strain gages in different directions, is used. Fig. 7 shows a three-element strain gage rosette stacked at 45°.

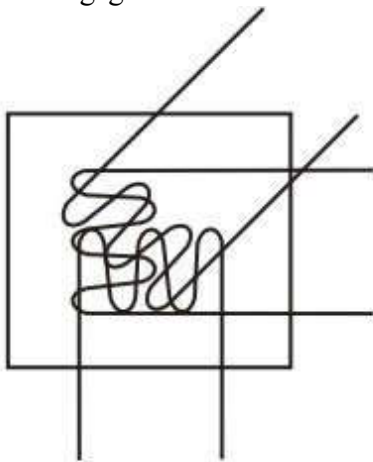

Fig. 7 Three-element strain gage rosette- 45° stacked.

The *backing material*, over which the strain gage is fabricated and which is fixed with the strain measuring structure has to satisfy several important properties. Firstly, it should have high mechanical strength; it should also have high dielectric strength. But the most important it should have is that it should be non-hygroscopic, otherwise, absorption of moisture will cause bulging and generate local strain. The backing materials normally used are impregnated paper, fibre glass, etc. The *bonding material* used for fixing the strain gage permanently to the structure should also be non-hygroscopic. Epoxy and Cellulose are the bonding materials normally used.

### Semiconductor type Strain Gage

Semiconductor type strain gage is made of a thin wire of silicon, typically 0.005 inch to 0.0005 inch, and length 0.05 inch to 0.5 inch. They can be of two types: *p*-type and *n*-type. In the former the resistance increases with positive strain, while, in the later the resistance decreases with temperature. The construction and the typical characteristics of a semiconductor strain gage are shown in fig.8. MEMS pressure sensors is now a days becoming increasingly popular for measurement of pressure. It is made of a small silicon diagram with four piezo-resistive strain gages mounted on it. It has an in- built signal conditioning circuits and delivers measurable output voltage corresponding to the pressure applied. Low weight and small size of the sensor make it suitable for measurement of pressure in specific applications.

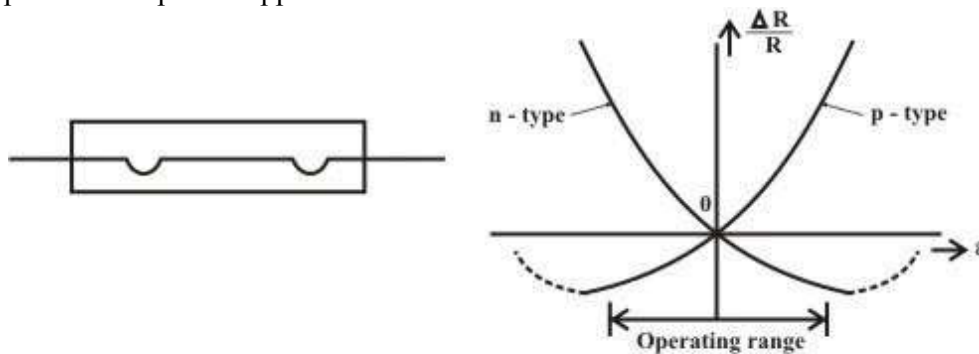

Fig. 8 (a) construction and (b) characteristics of a semiconductor strain gage

## Thermistors:

Basically thermistor is a contraction of a word 'thermal resistors', The resistors depending on temperature are thermal resistors. Thus resistance thermometers are also thermistors having positive -temperature coefficients. But generally the resistors having negative temperature coefficients (NTC) are called thermistors. The resistance of a thermistor decreases as temperature increases. The NTC of thermistors can be as large as few percent per degree celcius change in temperature. Thus the thermistors are very sensitive and can detect very small changes in temperature too.

## Construction of thermistor:

Thermistors are composed of a sintered mixture of metallic oxides, such as manganese, nickel, cobalt, copper, iron, and uranium. Their resistances at ambient temperature may range from 100  $\Omega$  to 100  $k\Omega$ . Thermistors are available in a wide variety of shapes and sizes as shown in the Fig. Smallest in size are the beads with a diameter of 0.15 mm to 1.25 mm. Beads may be sealed in the tips of solid glass rods to form probes. Disks and washers are made by pressing thermistor materia~ under high pressure into flat cylindrical shapes. Washers can be placed in series or in parallel to increase power dissipation rating.

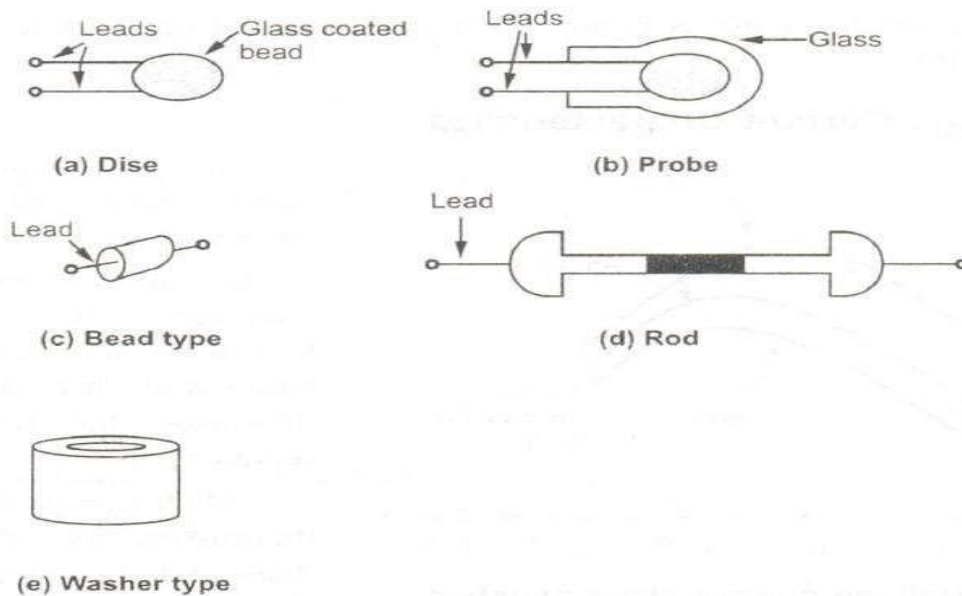

Thermistors are well suited for precision temperature measurement, temperature control, and temperature compensation, because of their very large change in resistance with temperature. They are widely used for measurements in the temperature range  $-1000\text{ C}$  to  $+2000\text{ C}$ . The measurement of the change in resistance with temperature is carried out with a Wheatstone bridge.

**Inductive transducers** work on the principle of inductance change due to any appreciable change in the quantity to be measured i.e. measured. For example, LVDT, a kind of **inductive transducers**, measures displacement in terms of voltage difference between its two secondary voltages. Secondary voltages are nothing but the result of induction due to the flux change in the secondary coil with the displacement of the iron bar. Anyway LVDT is discussed here briefly to explain the principle of **inductive transducer**. LVDT will be explained in other article in more detail. For the time being let's focus on basic introduction of **inductive transducers**. Now first our motive is to find how the **inductive transducers** can be made to work. This can be done by changing the flux with the help of measured and this changing flux obviously changes the inductance and this inductance change can be calibrated in terms of measured. Hence **inductive transducers** use one of the following principles for its working.

1. Change of self inductance
2. Change of mutual inductance
3. Production of eddy current

### Change of Self Inductance of Inductive Transducer

We know very well that self inductance of a coil is given by  $L = \frac{N^2}{R}$  Where, N = number of turns. R

= reluctance of the magnetic circuit. Also we know that reluctance R is given by  $R = \frac{l}{\mu A}$

$L = \frac{N^2 \mu A}{l}$  where  $\mu$  = effective permeability of the medium in and around the coil.

$L = N^2 \mu G$  Where,  $G = A/l$  and called geometric form factor. A = area of cross-section of coil. l = length of the coil. So, we can vary self inductance by

- Change in number of turns, N,
- Changing geometric configuration, G,
- Changing permeability

For the sake of understanding we can say that if the displacement is to be measured by the **inductive transducers**, it should change any of the above parameter for causing in the change in self inductance.

### Change of Mutual Inductance of Inductive Transducer

Here transducers, which work on change of mutual inductance principle, use multiple coils. We use here two coils for the sake of understanding. Both coils have their self inductance as well. So let's denote their self inductance by  $L_1$  and  $L_2$ . Mutual inductance between these two coils is given by

$$M = K \sqrt{L_1 L_2}$$

Thus mutual inductance can be changed by varying self inductance or by varying coefficient of coupling, K. The methods of changing self inductance we already discussed. Now coefficient of coupling depends on the distance and orientation between two coils. Thus for the measurement of displacement we can fix one coil and make other movable which moves with the source whose displacement is to be measured. With the change in distance in displacement coefficient of coupling changes and it causes the change in mutual inductance. This change in mutual inductance can be calibrated with the displacement and measurement can be done.



### Production of Eddy Current of Inductive Transducer

We know that when a conducting plate is placed near a coil carrying alternating current, a circulating current is induced in the plate called “EDDY CURRENT”. This principle is used in such type of **inductive transducers**. Actually what happens? When a coil is placed near to coil carrying alternating current, a circulating current is induced in it which in turn produces its own flux which try to reduce the flux of the coil carrying the current and hence inductance of the coil changes. Nearer the plate is to the coil, higher will be eddy current and higher is the reduction in inductance and vice versa. Thus inductance of coil varied with the variation of distance between coil and plate. Thus the movement of the plate can be calibrated in terms of inductance change to measure the quantity like displacement.

### Real Life Application of Inductive Transducer

**Inductive transducers** find application in proximity sensors which are used for position measurement, dynamic motion measurement, touch pads etc. Particularly **inductive transducer** is used for the detection of type of metal, finding missing parts or counting the number of objects.

### Linear variable differential transformer (LVDT)

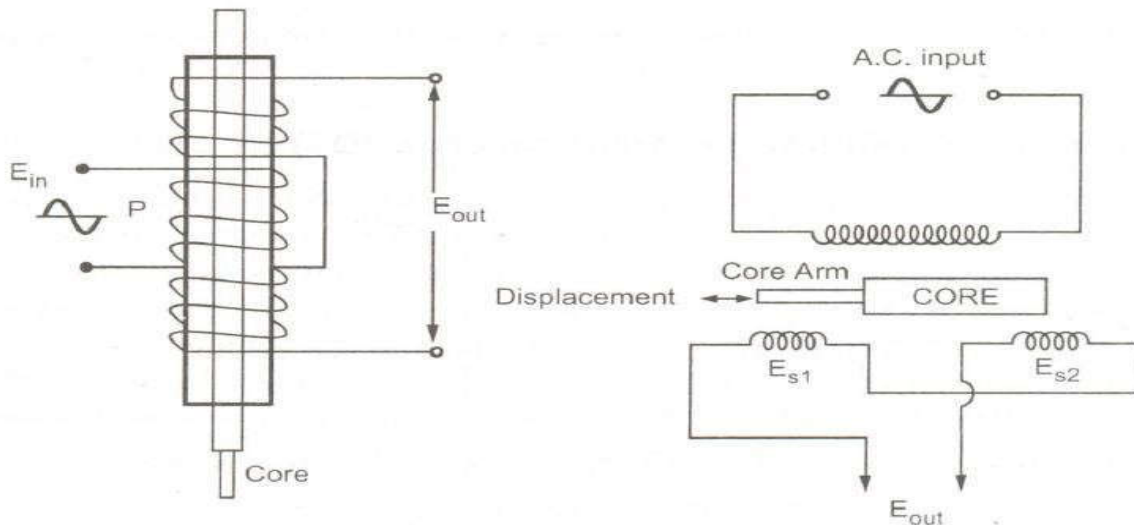

When an externally applied force moves the core to the left-hand position, more magnetic flux links the left-hand coil than the righthand coil. The emf induced in the left-hand coil,  $E_{s1}$ , is therefore larger than the induced emf of the right-hand [oil,  $E_{s2}$ ]. The magnitude of the output voltage is then equal to the difference between the two secondary voltages and it is in phase with the voltage of the left-hand coil.

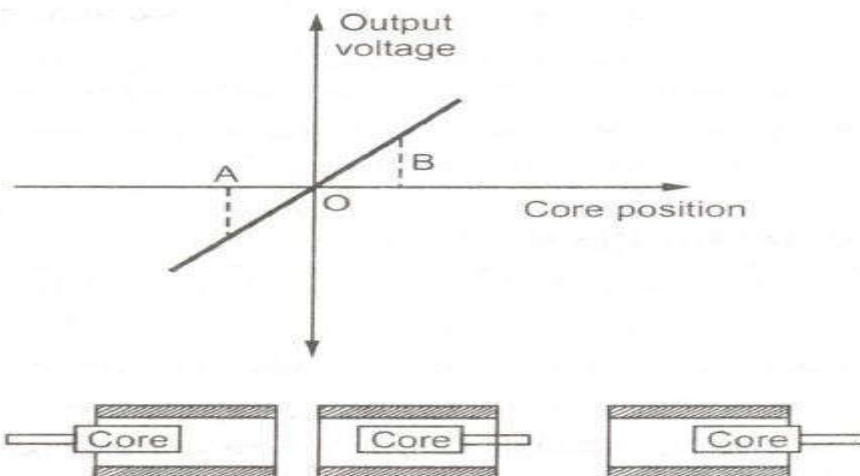

Output voltage of LVDT at different core positions

## Construction of LVDT

Main Features of Construction are as,

- The transformer consists of a primary winding P and two secondary winding S1 and S2 wound on a cylindrical former(which is hollow in nature and will contain core).
- Both the secondary windings have equal number of turns and are identically placed on the either side of primary winding
- The primary winding is connected to an AC source which produces a flux in the air gap and voltages are induced in secondary windings.
- A movable soft iron core is placed inside the former and displacement to be measured is connected to the iron core.
- The iron core is generally of high permeability which helps in reducing harmonics and high sensitivity of LVDT.
- The LVDT is placed inside a stainless steel housing because it will provide electrostatic and electromagnetic shielding.
- The both the secondary windings are connected in such a way that resulted output is the difference of the voltages of two windings.

## Principle of Operation and Working

As the primary is connected to an AC source so alternating current and voltages are produced in the secondary of the LVDT. The output in secondary S<sub>1</sub> is e<sub>1</sub> and in the secondary S<sub>2</sub> is e<sub>2</sub>. So the differential output is,  $e_{out} = e_1 - e_2$  This equation explains the **principle of Operation of LVDT**.

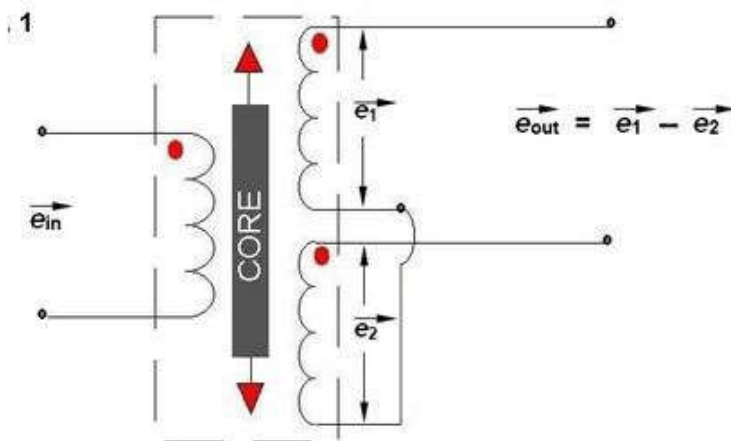

Now three cases arise according to the locations of core which explains the working of LVDT are discussed below as,

- **CASE I** When the core is at null position (for no displacement) When the core is at null position then the flux linking with both the secondary windings is equal so the induced emf is equal in both the windings. So for no displacement the value of output  $e_{out}$  is zero as  $e_1$  and  $e_2$  both are equal. So it shows that no displacement took place.
- **CASE II** When the core is moved to upward of null position (For displacement to the upward of reference point) In the this case the flux linking with secondary winding S<sub>1</sub> is more as compared to

flux linking with  $S_2$ . Due to this  $e_1$  will be more as that of  $e_2$ . Due to this output voltage  $e_{out}$  is positive.

- **CASE III** When the core is moved to downward of Null position (for displacement to the downward of reference point) In this case magnitude of  $e_2$  will be more as that of  $e_1$ . Due to this output  $e_{out}$  will be negative and shows the output to downward of reference point.

**Output Vs Core Displacement** A linear curve shows that output voltage varies linearly with displacement of core.

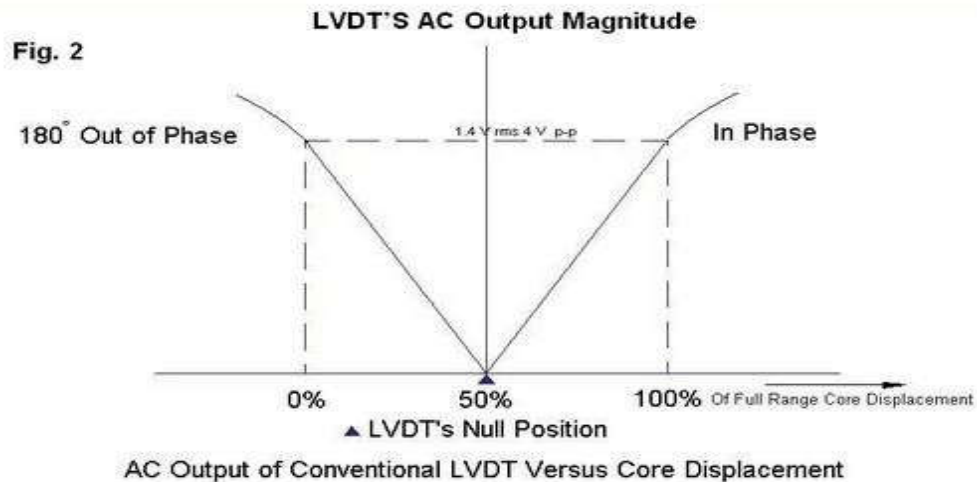

**Some important points about magnitude and sign of voltage induced in LVDT**

- The amount of change in voltage either negative or positive is proportional to the amount of movement of core and indicates amount of linear motion.
- By noting the output voltage increasing or decreasing the direction of motion can be determined
- The output voltage of an LVDT is linear function of core displacement .

**Advantages of LVDT**

- **High Range** - The LVDTs have a very high range for measurement of displacement.they can used for measurement of displacements ranging from 1.25mm to 250mm
- **No Frictional Losses** - As the core moves inside a hollow former so there is no loss of displacement input as frictional loss so it makes LVDT as very accurate device.
- **High Input and High Sensitivity** - The output of LVDT is so high that it doesn't need any amplification.the transducer posseses a high sensitivity which is typically about 40V/mm.
- **Low Hysteresis** - LVDTs show a low hysteresis and hence repeatability is excellent under all conditions
- **Low Power Consumption** - The power is about 1W which is very as compared to other transducers.
- **Direct Conversion to Electrical Signals** - They convert the linear displacement to electrical voltage which are easy to process

### Disadvantages of LVDT

- LVDT is sensitive to stray magnetic fields so they always require a setup to protect them from stray magnetic fields.
- They are affected by vibrations and temperature.

It is concluded that they are advantageous as compared than any other inductive transducers.

### Applications of LVDT

1. They are used in applications where displacements ranging from fraction of mm to few cm are to be measured. The LVDT acting as a primary Transducer converts the displacement to electrical signal directly.
2. They can also acts as the secondary transducers. E.g. the Bourbon tube which acts as a primary transducer and covert pressure into linear displacement.then LVDT coverts this displacement into electrical signal which after calibration gives the ideas of the pressure of fluid.

### Capacitive Transducers

A capacitor consists of two conductors (plates) that are electrically isolated from one another by a nonconductor (dielectric). When the two conductors are at different potentials (voltages), the system is capable of storing an electric charge. The storage capability of a capacitor is measured in farads.The principle of operation of capacitive transducers is based upon the equation for capacitance of a parallel plate capacitor as shown in Fig.

**Capacitance**       $C = \frac{\epsilon A}{d}$

Where,      A = Overlapping area of plates; m<sup>2</sup>,  
                   d = Distance between two plates; m,  
                   ε = Permittivity (dielectric constant); F/m.

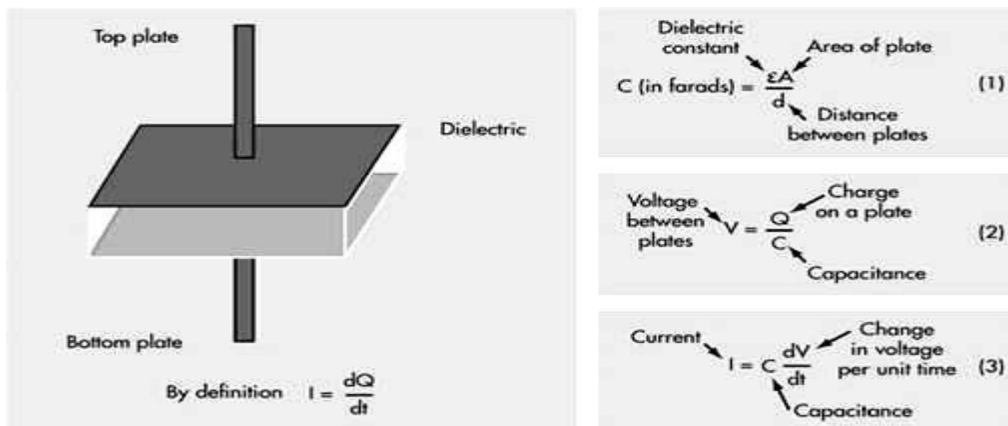

**Fig. Parallel plate capacitor**

The capacitance is measured with a bridge circuits. The output impedance  $Z$  of a capacitive transducer is:

$$Z = 1/2\pi fC$$

Where:  $Z$  = Impedance  
 $f$  = frequency, 50 Hz.  
 $C$  = capacitance

In general, the output impedance of a capacitive transducer is high. This fact calls for a careful design of the output circuitry. The capacitive transducers work on the principle of change in capacitance of the capacitor. This change in capacitance could be caused by change in overlapping area  $A$  of the plates, change in the distance  $d$  between the plates and change in dielectric constant  $\epsilon$

In most of the cases the above changes are caused by the physical variables, such as, displacement, force or pressure. Variation in capacitance is also there when the dielectric medium between the plates changes, as in the case of measurement of liquid or gas levels. Therefore, the capacitive transducers are commonly used for measurement of linear displacement, by employing the following effects as shown in Fig a and fig b.

- i) Change in capacitance due to change in overlapping area of plates.
- ii) Change in capacitance due to change in distance between the two plates.
- iii) Change in capacitance due to change in dielectric between the two plates

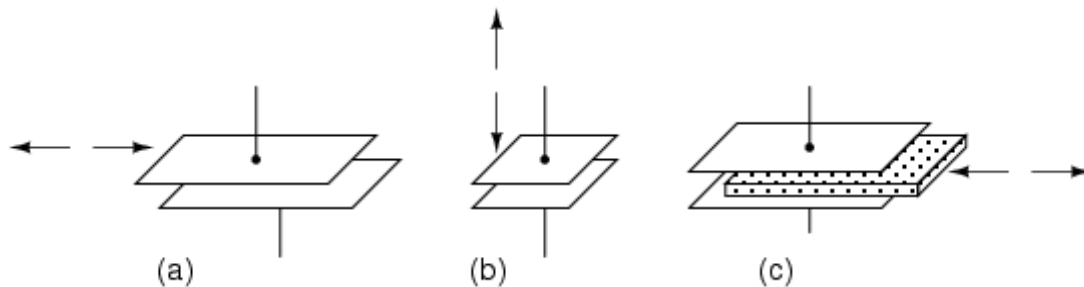

**Fig.a Variable capacitive transducer varies; (a) area of overlap, (b) distance between plates, (c) amount of dielectric between plates**

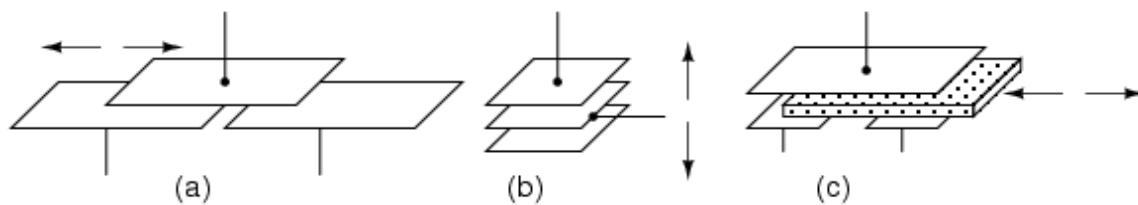

**Fig.b Differential capacitive transducer varies capacitance ratio by changing: (a) area of overlap, (b) distance between plates, (c) dielectric between plates**

As may be seen in Fig b, all of the differential devices have three wire connections rather than two: one wire for each of the end plates and one for the common plate. As the capacitance between one of the endplates and the common plate changes, the capacitance between the other end plate and the common plate also changes in the opposite direction.

#### a) Transducers Using Change in Area of Plates

Examining the equation for capacitance, it is found that the capacitance is directly proportional to the area, A of the plates. Thus, the capacitance changes linearly with change in area of plates. Hence this type of capacitive transducer is useful for measurement of moderate to large displacements say from 1 mm to several cm. The area changes linearly with displacement and also the capacitance.

For a parallel plate capacitor, the capacitance is:

$$C = \frac{\epsilon A}{d} = \frac{\epsilon l w}{d} F$$

Where,  $l$  = length of overlapping part of plates; m, and  
 $w$  = width of overlapping part of plates; m.

$$\text{Sensitivity} \quad S = \frac{\partial C}{\partial l} = \epsilon \frac{w}{d} F/m$$

The sensitivity is constant and therefore there is linear relationship between capacitance and displacement.

This type of a capacitive transducer is suitable for measurement of linear displacement ranging from 1 to 10 cm. The accuracy is as high as 0.005%.

#### b) Transducers Using Change in Distance between Plates

Fig. 17.2(b) shows the basic form of a capacitive transducer employing change in distance between the two plates to cause the change in capacitance. One plate is fixed and the displacement to be measured is applied to the other plate which is movable. Since, the capacitance, C, varies inversely as the distance d, between the plates the response of this transducer is not linear. Thus this transducer is useful only for measurement of extremely small displacements.

$$\text{Sensitivity} \quad S = \frac{\partial C}{\partial l} = -\frac{\epsilon A}{d^2}$$

Thus the sensitivity of this type of transducer is not constant but varies over the range of the transducer. The relationship between variations of capacitance with variation of distance between plates is hyperbolic and is only approximately linear over a small range of displacement. The linearity can be closely approximated by use of a piece of dielectric material like mica having a high dielectric constant, such as, a thin piece of mica.

### c) Transducers Using Change in dielectric constant between Plates

If the area ( $A$ ) of and the distance ( $d$ ) between the plates of a capacitor remain constant, capacitance will vary only as a function of the dielectric constant ( $\epsilon$ ) of the substance filling the gap between the plates. If the space between the plates of a capacitor is filled with an insulator, the capacitance of the capacitor will change compared to the situation in which there is vacuum between the plates. The change in the capacitance is caused by a change in the electric field between the plates.

The value of dielectric constant is initially set by design in the choice of dielectric material used to make the capacitor. Many factors will cause the  $\epsilon$  to change, and this change in  $\epsilon$  will vary for different materials. The major factors that will cause a change in  $\epsilon$  are moisture, voltage, frequency, and temperature. The dielectric constant of a process material can change due to variations in temperature, moisture, humidity, material bulk density, and particle size etc. The  $\epsilon$  in the basic formula is the effective dielectric constant of the total space between the electrodes. This space may consist of the dielectric material, air, and even moisture, if present. The figure shows that how in a capacitor the position of the dielectric is varied to vary the capacitance. Physical variables, such as, displacement, force or pressure can cause the movement of dielectric material in the capacitor plates, resulting in changes in the effective dielectric constant, which in turn will change the capacitance.

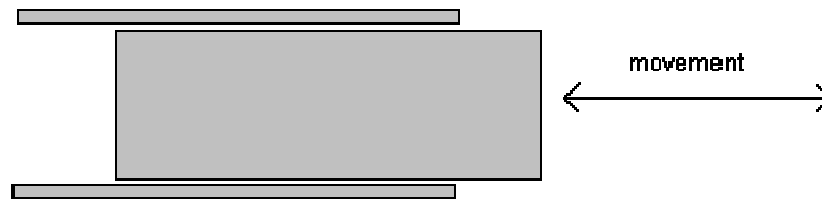

**Fig. Change in capacitance due to movement of dielectric between plates**

The major advantages of capacitive transducers are that they require extremely small forces to operate them and hence are very useful for use in small systems. They are extremely sensitive and require small power to operate them. Owing to their good frequency response they are very useful for dynamic studies.

The disadvantages of capacitive transducers include their non-linear behaviour on account of edge effects and the effects of stray capacitances especially when the transducers have a low value of capacitance. Therefore guard rings must be used to eliminate this effect. The metallic parts of the capacitive transducers must be insulated from each other. In order to reduce the effects of stray capacitances, the frames must be earthed.

Capacitive transducers can be used for measurement of both linear and angular displacements. The capacitive transducers are highly sensitive and can be used for measurement of extremely

small displacements down to the order of molecular dimensions, i.e.,  $0.1 \times 10^{-6}$  mm. On the other hand, they can be used for measurement of large displacements up to about 30 m as in aeroplane altimeters. The change in area method is used for measurement of displacements ranging from 10 to 100 mm. Capacitive transducers can be used for the measurement of force and pressure. The force and pressure to be measured are first converted to displacement which causes a change of capacitance. Capacitive transducers can also be used directly as pressure transducers in all those cases where the dielectric constant of a medium changes with pressure. They can be used for measurement of humidity in gases and moisture content in soil / food products etc.

**Piezoelectric transducer:**

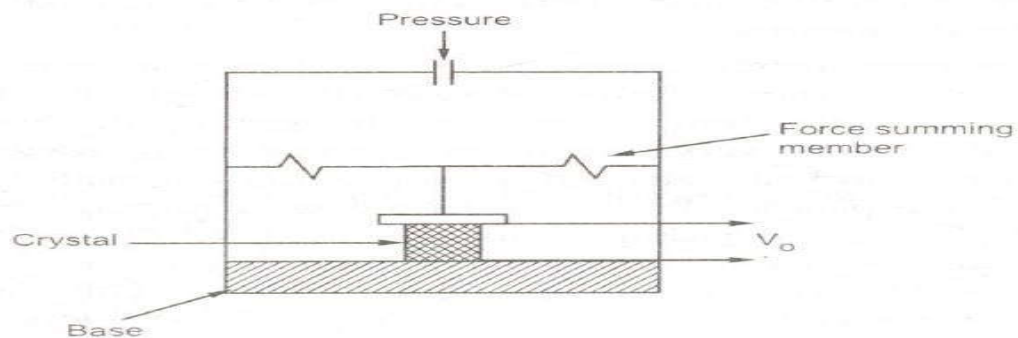



## Force and Torque Measurement

Force: - Force is defined as the product mass and acceleration.

$$F = ma$$

F = Force, in Newton

M = Mass, in kg

A = Acceleration, in  $\text{kg/m}^2$

Force Measurement Technique: - Now a day's, electric based measurement methods are used where load cell is the prime element used for force measurement. The electronic signal obtain can directly to given the computer after processing and data can be displayed.

- 1) Using mechanical balance. Balancing the unknown force against the known gravitational force on a standard mass.
- 2) By evaluating the acceleration of a body of known mass to which the unknown force is applied.
- 3) Using various types of load cell –
  - Hydraulic load cell.
  - Pneumatic load cell.
  - Strain gauge based load cell.
  - Using electric Member.
- 4) Using electromagnetic based balance.

◆Mechanical Balance: - In this type, the unknown force is balanced against the standard known weight.

Classified into following types -

- a) Analytical Balance.
- b) Balance with pendulum type scale.
- c) Platform type scale balance.

- a) Analytical Balance :- It consist of a beam which is designed so that centre of mass is slightly below the pivot and thus, barely equilibrium. Analytical balance is a measure of the angular displacement  $\theta$  per unit unbalance in two weight  $w_1$  and  $w_2$

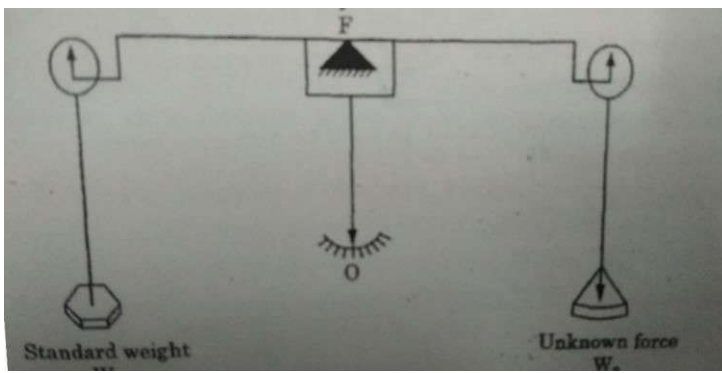

Balance with pendulum: - This type is used for static force measurement. The unknown force  $F$  is applied through a section of levers. This torque is then balanced by torque produced by a standard fixed mass arrangement as a pendulum. The deflection  $Q$  can be sensed through angular displacement transducers to get the o/p electrical signal which is proportional to the applied force.

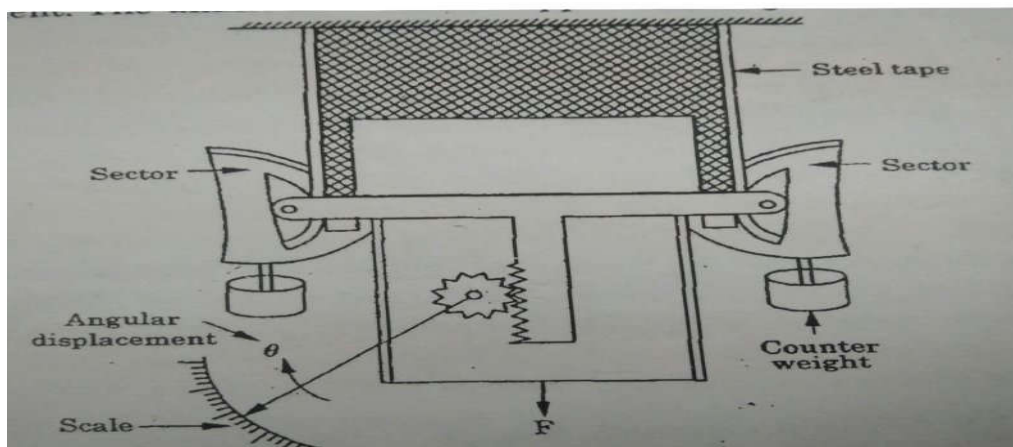

Platform scale: - This type of scale is used to measure large force by using much smaller standard weight. In this type of scale, beam of scale is brought to null by proper combination of pan weight and adjusting the poise weight lever arm along its calibrated scale.

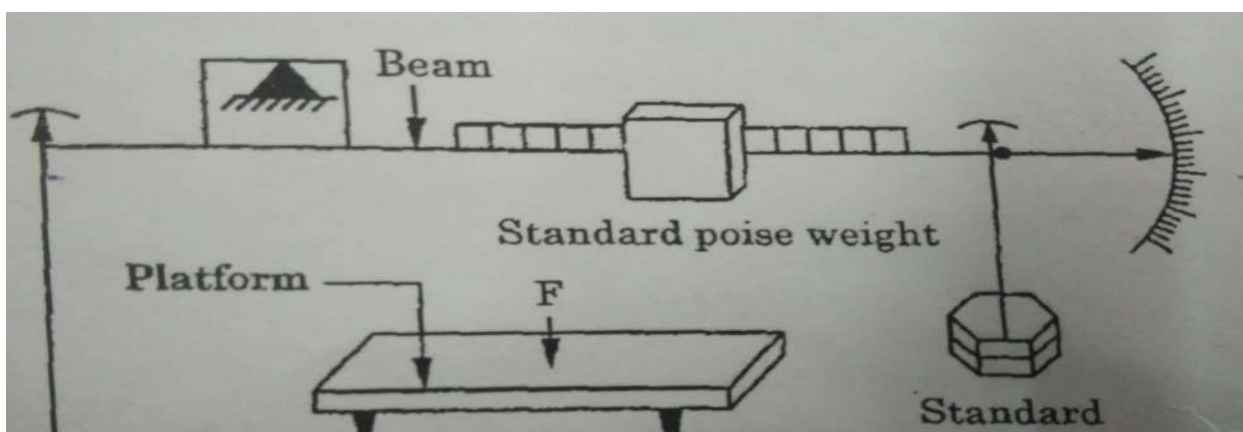

◆ Electromagnetic type balance: - A photoelectric sensor is used which act as null detector in the circuit. A servo system is used which consists of photo tube , and amplifier and coil on which torque is produced.

This servo system balances the difference between unknown force  $F$  and gravitational force as standard mass  $H$ .

ADVANTAGES:-

- 1) It is small in size.
- 2) Their response is quick.
- 3) Electrical output can be used for recording.

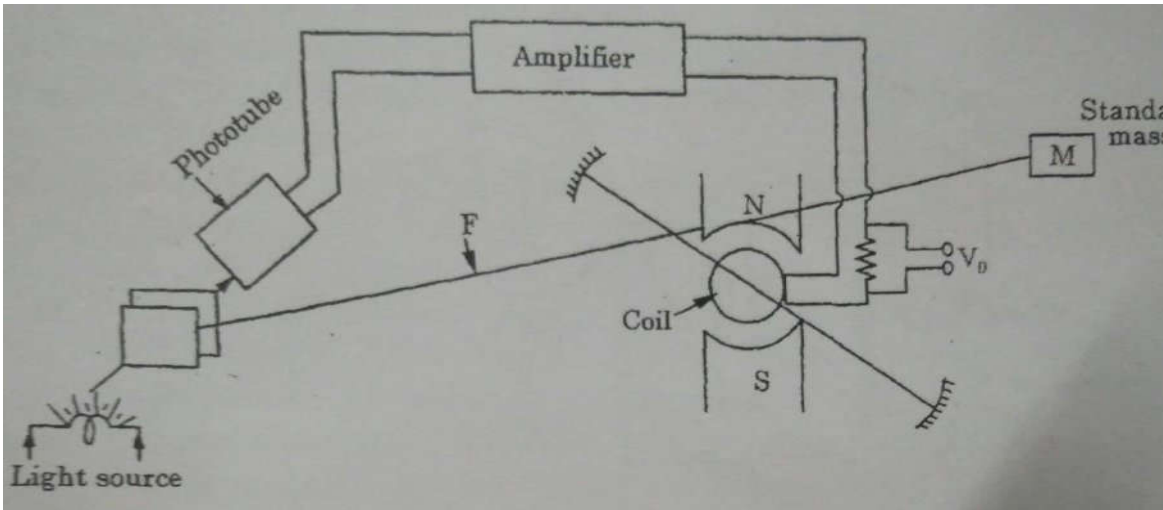

◆ Load cell :- A load cell is an electronic device that is used to convert force into an electrical signal. Load cell utilize the elastic member as the primary transducers and strain gauge as secondary transducers. Strain gauge attached to any elastic member. When the strain gauge – elastic member combination is used for weighing it is called a load cell.

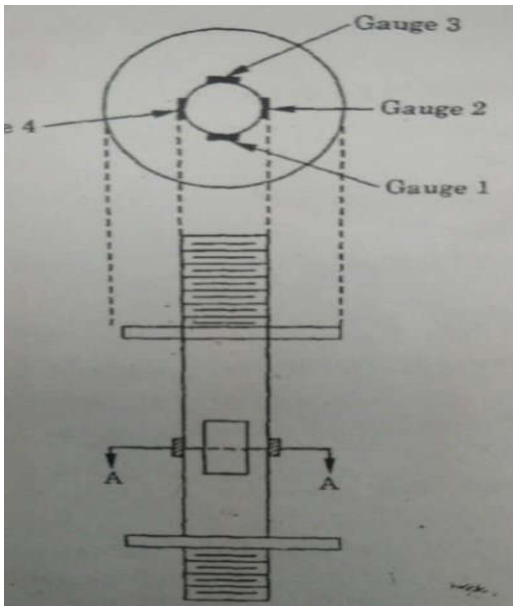

Strain Gauge Load cell :- This cell convert the load acting them into electrical signal.

In strain gauge load cell, a length of bar, usually steel, is used as the active element. The gauge themselves are bonded onto a beam or structural member that deform when weight is applied. Shown a strain gauge load cell.

As the stress is applied across the direction of S, the steel bar experience a compression along that axis and expansion along the X and Y axis.

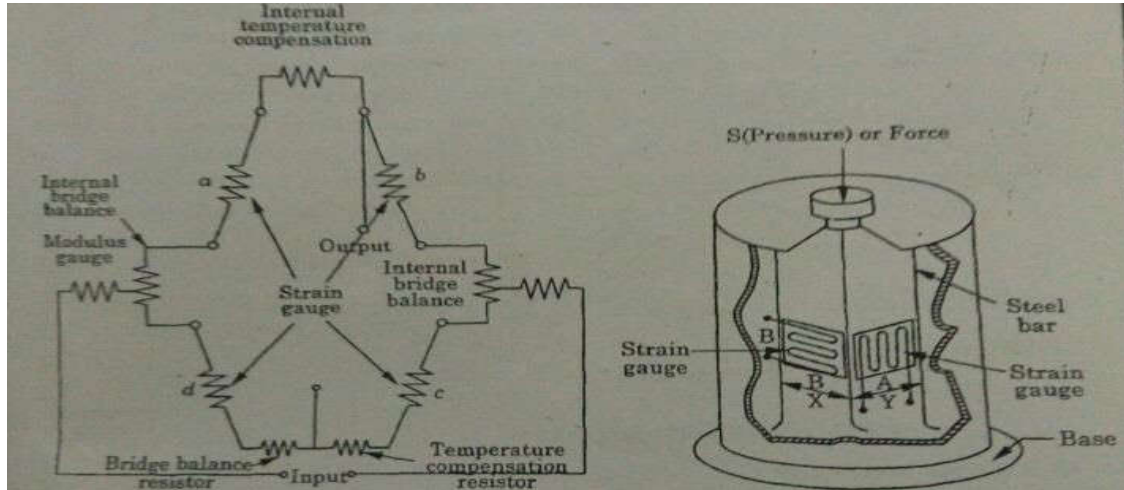

As the result, Gauge a experience a decrease in resistance, while gauge B undergoes an increase in resistance. This makes the load cell sensitive to very small value of applied stress.

This change in resistance of the strain gauge causes the wheat stone bridge, which directly proportional to the applied force bridge.

#### ADVANTAGES:-

- 1) Response time is very good.
- 2) Small and compact of size.
- 3) These are inexpensive.
- 4) Usually maintenance free.

#### Limitations:-

- 1) These should not be over loaded over their rating value.
- 2) These should be protected from non – axial load.

Hydraulic Load Cell :- Hydraulic load cell are force – balance device, measuring weight as a change in pressure of the internal filling fluid. In a rolling diaphragm type hydraulic load cell, a load or force acting on a loading head is transferred to a piston that in turn compresses a filling fluid confined within an elastomeric diaphragm chamber. As force increase, the pressure of the hydraulic fluid rises. The pressure can be locally indicated or transmitted for remote indication or control.

Typical hydraulic load cell applications include tank, bin , and hopper weighing. The output of the cell can be sent to a hydraulic totalize that sums the load cells signals and generates an output representing their sum. Electronic totalizes can also be used .

Pneumatic load cell :- Pneumatic load cell also operate on the force – balance principle, This device use multiple dampener chamber to provide higher accuracy that hydraulic device. This load cell are often used to measure relatively small weight in industry where cleanliness and safety of prime concern.

The advantage of this type of load cell include their being inherently explosion proof and insensitive to temp variation.

Disadvantage: - Include relatively slow speed of response and need for clean, dry, regulated air or nitrogen.

◆ Torque Measurement :- It is defined as the force acting on a body which tends to produce rotation.

$$T = F \times D$$

T = Torque

F = Force

D = Perpendicular Distance from the axis of rotation of line of action of force.

MEASUREMENT OF TORQUE :- Torques measured by either sensing the actual shaft deflection caused by a twisting force. The surface of a shaft under torque will experience compression and tension to measure Torque, strain gauge element usually are mounted in pair on the shaft , one gauge measuring the increasing in length , the other measuring the decreases in length in the other direction.

A number of device that are used for the measurement of torque are –

- 1) Strain gauge torque meter.
- 2) Inductive torque meter.
- 3) Magnetostrictive transducers
- 4) Digital method.
- 5) Proximity sensor for torque measurement.

Strain Gauge Torque Meter :- In this method two strain gauge are mounted on a shaft at an analog 45 to each other. Cylindrical shaft connecting the driving and driven machine are used primary transducers strain gauge are mounted on the surface of shaft –

We know that torque is give by –

$$T = \pi G (R^4 - r^4)$$

$\frac{QL}{G}$  = Modules of rigidity;  $NIm^2$  r  
= inner radius of shaft; m  
R = outer radius of shaft; m L  
= Length of shaft; m  
Q = Angular deflection of shaft.

The two gauge are in tensile mode and other two in compressive mod. All the four gauge are available in the form of rosette. Slip rings are used for connecting the supply voltage to the bridge.

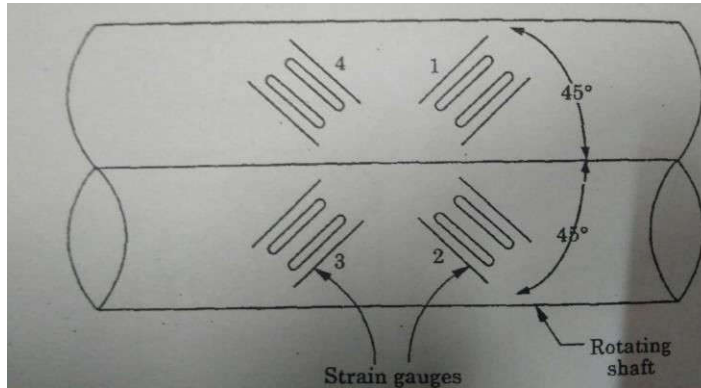

### ADVANTAGES:-

- 1) This arrangement compensates temperature completely.
- 2) Automatic compensation for bending and axial.
- 3) It give the maximum sensitivity for a given torque.

Inductive Torque Transducers: - In consist of a flange 'p' which carries a coil and flange on as iron case.

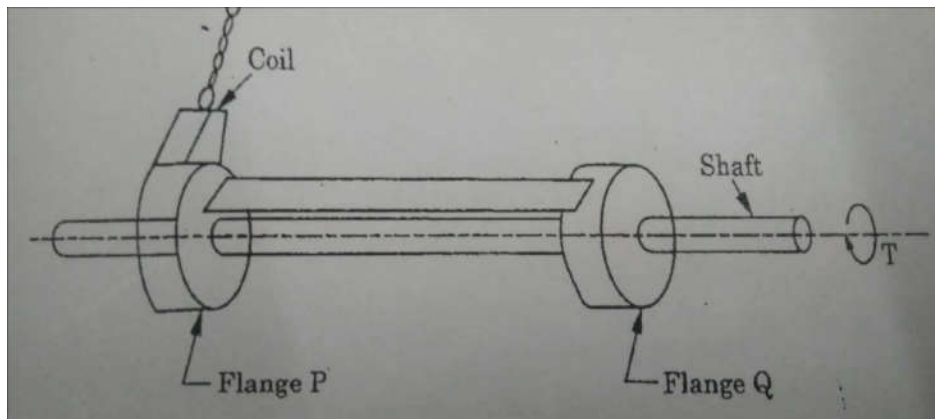

The core moves in and out of the coil according to relative displacement of the two flanges. The inductance of the coil is changed due to relative displacement. The coil is made on arm of A.c. Bridge. The output of a.c. bridge depends upon the inductance of the coil which in turn depends upon the position of core and hence the displacement. Because the displacement depends upon the torque, the bridge output can be directly calibrated to indicate the torque.

To have higher sensitivity and better linearity four inductive transducers are used with the coil connected as four arms of an a.c. bridge. Inductance of two coil increases, while the other two coil decreases, because of the movement of core due to torque applied to shaft in a given direction. Sensitivity of the bridge in this arrangement is increased four times as compared to the sensitivity obtained with a bridge using only one inductive transducers.

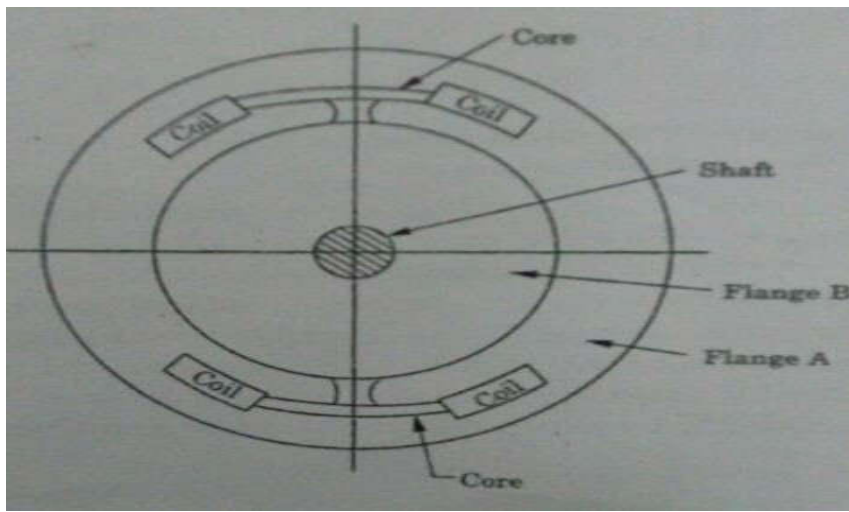

Digital Method: - Digital timing techniques can also be used for determination of relative between two flanges A and B.

Let us consider the case of flanges made in the form of single toothed wheels.

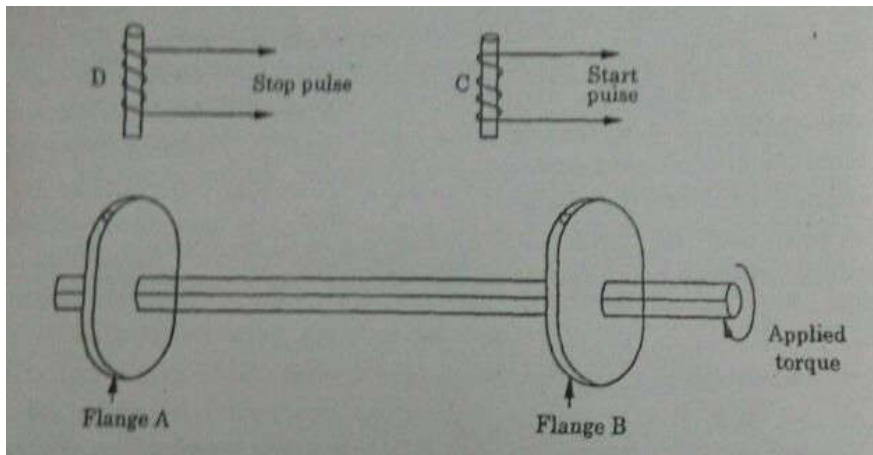

C and D are the inductive pickups where voltage

Pulse is produced by the teeth. When no torque is applied to the shaft, the teeth are perfectly aligned and when torque is applied to the shaft, there is relative displacement between the two flanges. When a torque is applied to the shaft, a phase shift is conducted pickups C and D. When these pulses are compared with the help of an electronic timer, it will show a time interval between the two pulses. This time interval is proportional to the relative displacement of two flanges which in turn is proportional to torque. In this way, torque is measured.

ADVANTAGES: - 1) Errors are eliminated.

2) Leakage of the signal.

3) No noise problem.



Magnetostrictive Transducers: - These are based on the principal that permeability of magnetic material changes when they are subjected to strain . Permeability decrease with positive strain and increases with negative strain.

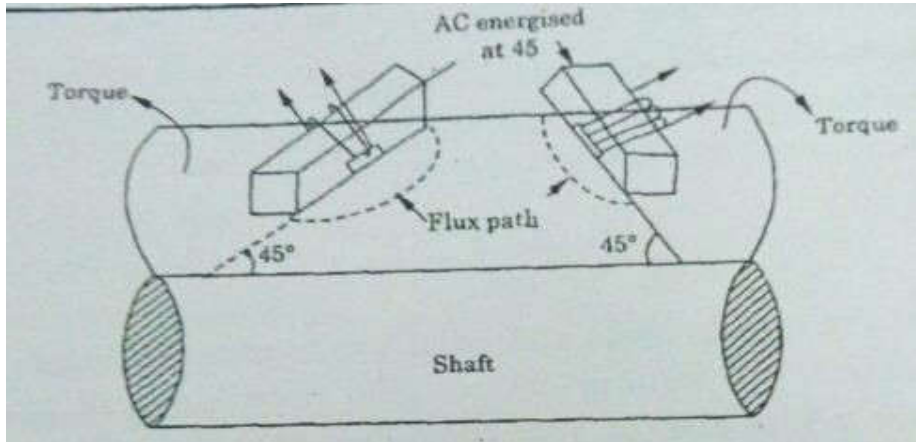

Two a.c energized coils are wound on iron cores. These are positioned close to the shaft so that their flux paths through the material of the shaft coincide with the directions of maximum strain. These coils form adjacent arms of an a.c bridge. The inductance of one of the coil increases due to increase in permeability and induct permeability. When no torque is applied, then bridge is balanced and two coils have equal inductance. When torque is applied, inductance in one coil increases and thus bridge becomes unbalanced.

This is due to differential change in inductance of the two coils caused by change in permeability of flux path due to application of torque. Hence the voltage output of the a.c bridge is inductive of the torque applied.

PROXIMITY SENSORS BASED TORQUE MEASUREMENT: These are used to measure the torque in a rotating shaft by measuring the angular displacement between the two sections of the rotating shaft.

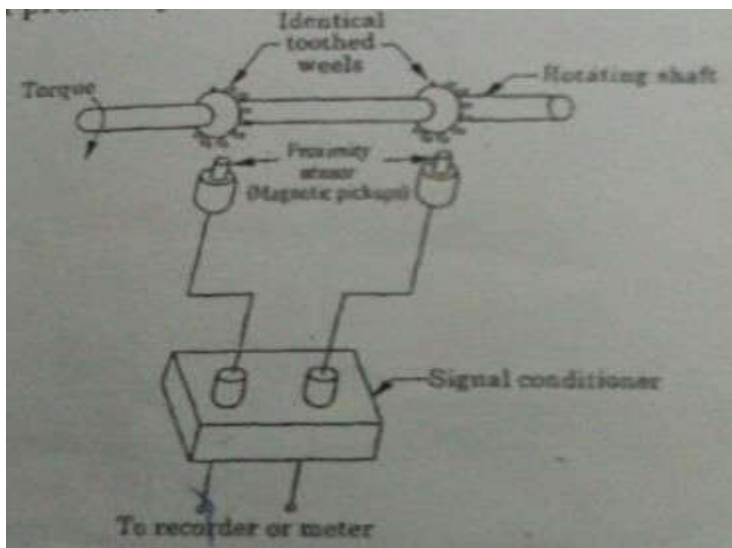



Two identical toothed wheels are fixed on a shaft, a certain distance apart. A each wheel, proximity sensor are placed.

When torque is applied, the shaft rotates and tooth of the wheel passes the proximity sensor due to which alternating voltage are produced, whose phase difference is proportional to the applied torque.

Measurement Of Speed (Angular Velocity):- speed is a scalar quantity equal to the magnitude of velocity . In industrial process, Speed as a variable refers to the revolution per minute of Some piece of rotating equipments.

These are many method of measurement; of tachometers are the most frequency used device. They are used for the measurement, of angular speed, usually in revolution per minute, (RPM) , although they can be used in many other meaningful units depending upon applications , such as feat per minute , miles per hour, yard per minute , or even in production units per unit time .

Various tachometers are:-

- 1) Mechanical tachometers
- 2) Optical tachometers
- 3) Stroboscope
- 4) A.C tachometers
- 5) D.C tachometers
- 6) Toothed wheel rotor type Speed sensor
- 7) Magnetic speed sensor

Mechanical Type Hand Held Tachometers:-

It consists of linear measuring wheels, adaptor for direct contact rpm sensing. A variety of rubber tipped wheels is present that transmit by friction the motion to be measured to the converts input shaft.

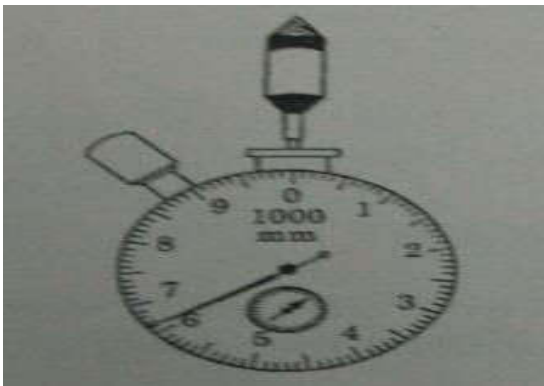

Photoelectric Speed Sensors :-

A beam of light is allowed to fall on a rotating disc which has been marked with light and dark areas. The disc is made to rotate at the speed of device whose speed is to be measured.

A photocell absorbs and reflects the light. Current pulses whose frequency is proportional to the speed of rotation are produced by the photocell. It is to be noted that the source of light and photocell are located on opposite side of a rotating perforated disc.

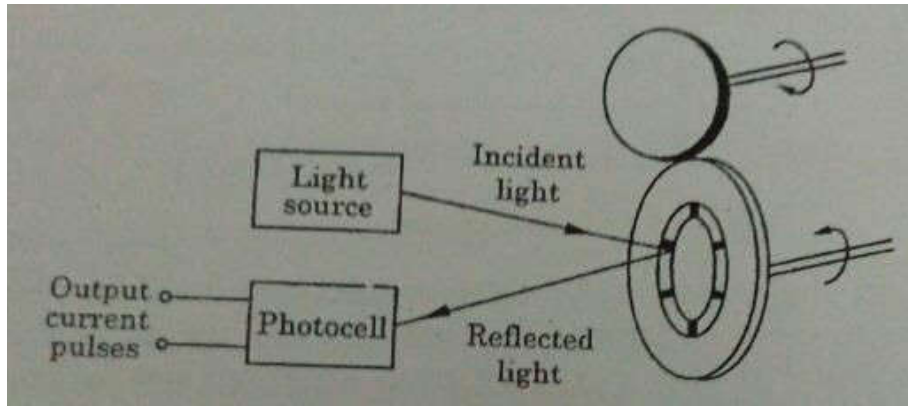

**Stroboscope:-** Stroboscope is a simpler, portable manually operated device which may be used for measurement of periodic or rotary motions. Basically, the instrument is a source of Variable frequency flashing brilliant light, the flashing being set by the operator.

A variable frequency oscillator is fixed in the circuit that controls the flashing frequency. The speed is measured by adjusting the frequency so that the moving objects are visible only at specific intervals of time. Thus this method is useful for only those types of motion which occur regularly after fixed intervals of time, such as application or rotation.

**A.C. Tachometer:-** An AC Tachometer, we have a rotating magnetic which may be either permanent magnet or an electromagnet.

An e.m.f is induced in the stator coil when magnet rotates. The amplitude and frequency of this induced e.m.f are both proportional to the speed of rotation. Thus either amplitude or frequency of induced voltage may be used as a measure of rotational speed.

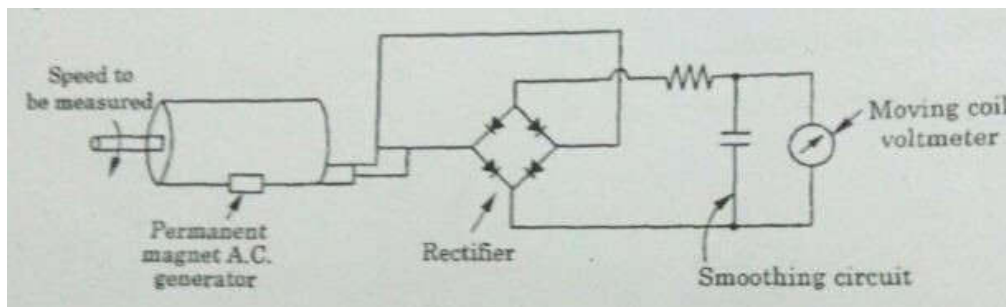

**D.C Tachometer:-** These consist of a small armature which is coupled to the machine whose speed is to be measured.

Since the e.m.f. generated is proportional to the product of flux and speed, but the flux of permanent magnet is constant, the voltage generated is proportional to speed. The e.m.f is measured with the help of moving coil voltmeter having a uniform scale and calibrated directly in terms of speed.

A series resistance is used in the circuit for the purpose of limiting the current from the generator in the event of a short circuit on the output side.

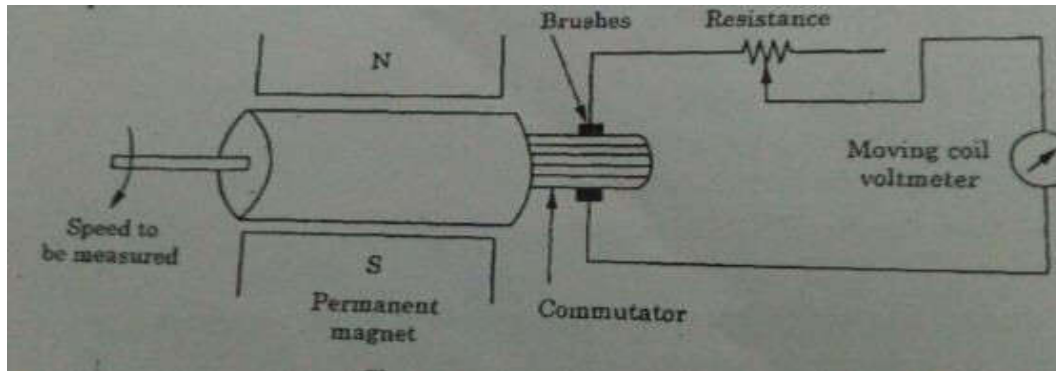

Toothed wheel rotor type speed sensor :-

These sensors are of induction type.

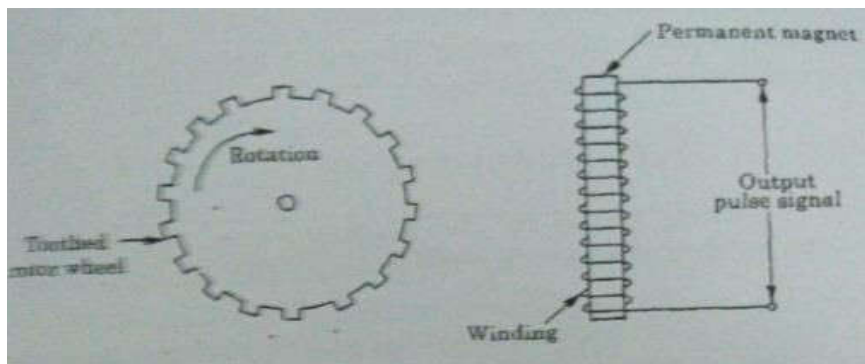

As the speed of toothed rotor is varied, magnetic field associated with coil varies accordingly. When toothed rotor rotates as per the speed to be measured, the teeth of rotor pass the magnet and disturb the magnetic field, which in turn induces voltage pulse in the coil .

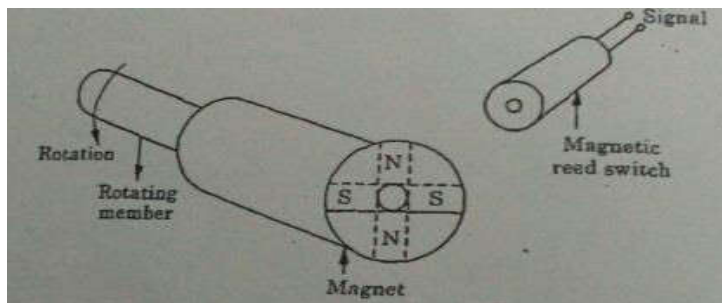

Magnetic Type Speed sensor: - In this technique, magnets are used to sense speed . A no. Of magnets are mounted on rotating member. Near to the rotating magnets, an assembly of Reed switch is kept. These reeds switch open or close when they pass through magnetic poles. The frequency of open close is proportional to magnetic poles speed. The output is thus a pulse train whose frequency is in proportion to the rotation speed.

# TORQUE

It is defined as the force acting on a body which tends to produce rotation.

Mathematically ,torque is given as :

$$T = F \times D$$

Where, T = torque

F = force

D = perpendicular distance from the axis of rotation of the line of action of force

A number of devices which can be used for the measurement of torque is :

1. Strain gauge torque meter
2. Inductive torque transducer
3. Magnetostrictive transducer
4. Digital methods

In this method , two strain gauges are mounted on a shaft at an angle of  $45^\circ$  to each other .

The torque is given by the relation ;

$$T = \frac{\pi G(R^4 - r^4)}{2L} \theta Nm$$

Where,  $G$  = modulus of rigidity measured in  $N/m^2$ .

$R$  = outer radius of the shaft measured in m.

$r$  = inner radius of the shaft measured in m.

$L$  = length of the shaft measured in m.

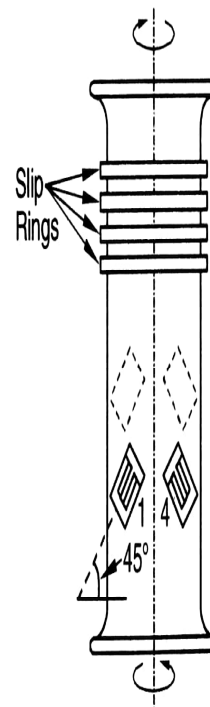

(a) Shaft with Strain Gauges

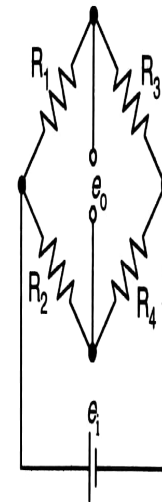

(b) Measurement of Torque of Rotating Shaft Using Strain Gauges

# THEORY:-

A strain gauge is generally measured by electrical means, In this arrangement , two strain gauges are subjected to tensile stresses while the other two experience Compressive stresses to indicated the torque.

The gauges must be at 45 with the shaft axis. Gauge 1 and 2 must be diametrically opposite , as must gauge 3 and 4 .

## ADVANTAGE

1. They are fully temperature compensate
2. they give a maximum sensitivity for a given torque

## 2. Inductive torque transducer

In inductive torque transducer, flange A carries a coil and flange B, an iron core. This core is move IN an OUT of the coil according to the relative displacement of the two flanges.

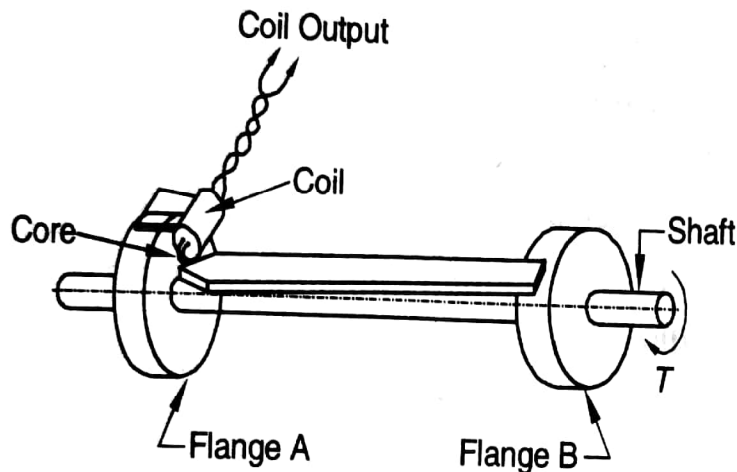

(a) Inductive Torque Transducer

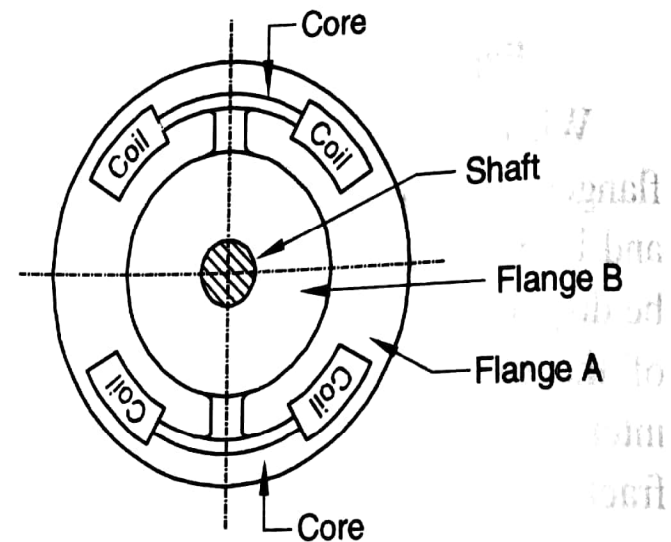

(b) Arrangement using four Inductive Transducers

# THEORY:

The coil used an arm of A.C bridge .

The displacement is depend upon torque.

The bridge output can be directly calibrated to read the torque.

The output of the A.C bridge is depend upon the inductance of the coil which in turn depends upon the position of core and hence on the displacement.



# 3. Magnetostrictive transducers

These are based on the principle that the permeability of magnetic material changes when they are subjected to strain . The permeability decreases with positive strain and increases with Negative strain .

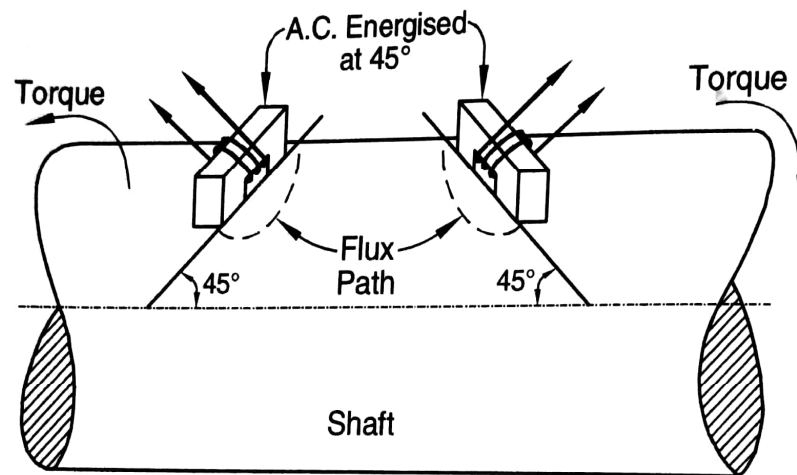

. Magnetostrictive transducer for the measurement of torque.

# **THEORY :-**

Magnetostrictive transducer is used for the measurement of torque.

The inductance of one of the coil increases due to the increase in permeability.

When an torque is applied, then bridge is balanced and two coil have equal inductance.

When torque is applied , inductance of one coil increases whereas inductance of another coil is decreases and hence , bridge is unbalanced..

# 4. Digital methods Types:-

1. single toothed wheel system
2. Multi- toothed wheel system

## Single toothed wheel system :-

Digital timing techniques are generally used for the determination of relative displacement between two flanges A and B .

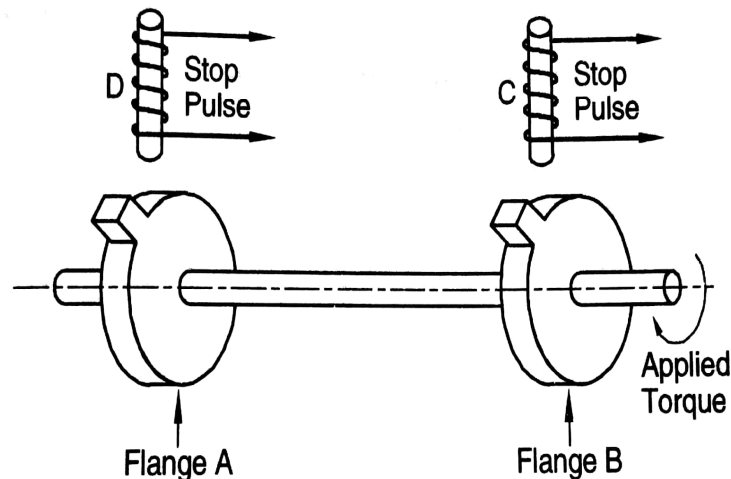

Torque transducer using single toothed flanges and inductive transducers.

# **THEORY :-**

When a torque is applied to the shaft, there is a relative displacement between the two flanges, and a phase shift is produced between the pulses in the inductive transducer C and D.

when these pulses are compared with the help of an electronic timer, a time interval will be displayed between the two pulses. this time interval is proportional to the relative displacement of the two flanges which in turn is proportional to the torque.

## **ADVANTAGE :-**

1. Errors are eliminated.
2. There is no noise problem.

## 2. Multi toothed wheel system

Multi-toothed wheels will replace the single-toothed wheels

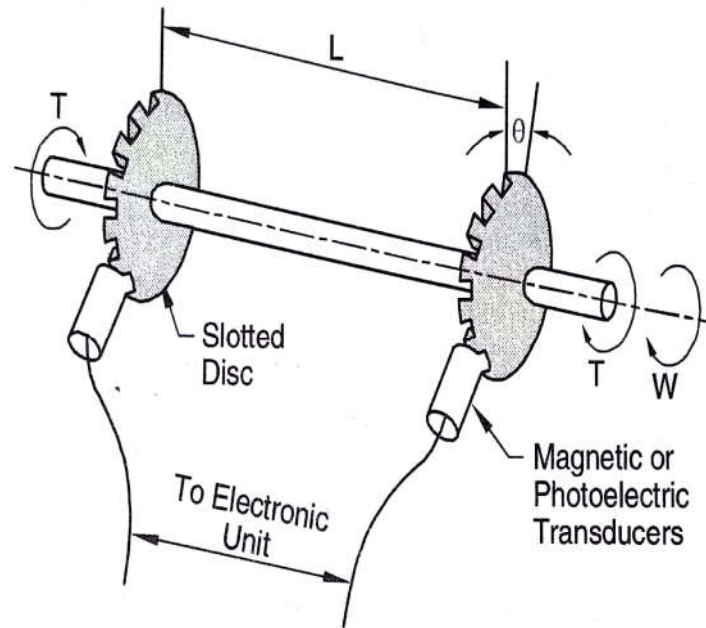

Torque measurements of rotating shafts using slotted discs and transducers.

# THEORY :-

The transducer are generally magnetic or photoelectric. In this case, the output is perfectly sinusoidal .

The two outputs are exactly in phase of the two wheels are correctly.

The output voltage progressively becomes out of phase as the torque increases because an increase in torque results in relative displacement of the two flanges.

# **Electromagnetic Flow Meter**

# Introduction

- A **Electromagnetic flow meter** is a volumetric flow meter which does not have any moving parts and is ideal for wastewater applications or any dirty liquid which is **conductive** or water based.



# Working Principle

- The operation of a **Electromagnetic flow meter** is based upon **Faraday's Law**, which states that:
- “The voltage induced across a conductor as it moves at right angles through the magnetic field is proportional to the velocity of that conductor.”

# Faraday's Law

According to this law the induced **voltage**  
**E** is proportional to  $\mathbf{V} \times \mathbf{B} \times \mathbf{D}$

where:

**E**= The voltage generated in a conductor

**V**= The velocity of the conductor

**B**= The magnetic field strength

**D**= The length of the conductor (in this instance distance between the electrodes)



- Electromagnetic flowmeter use Faraday's Law of electromagnetic induction to determine the flow of liquid in a pipe. In a magnetic flowmeter, a magnetic field is generated and channeled into the liquid flowing through the pipe. Following Faraday's Law, flow of a conductive liquid through the magnetic field cause a voltage signal to be sensed by electrodes located on the flow tube walls.

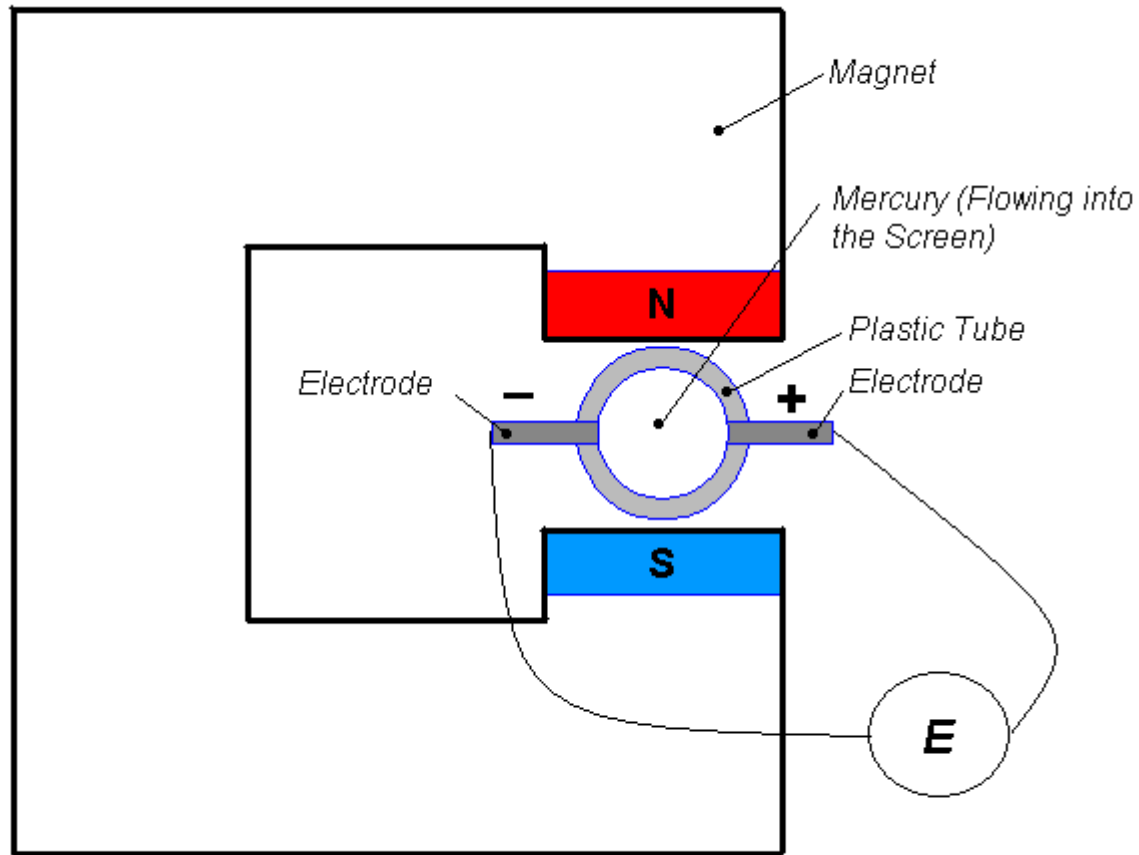

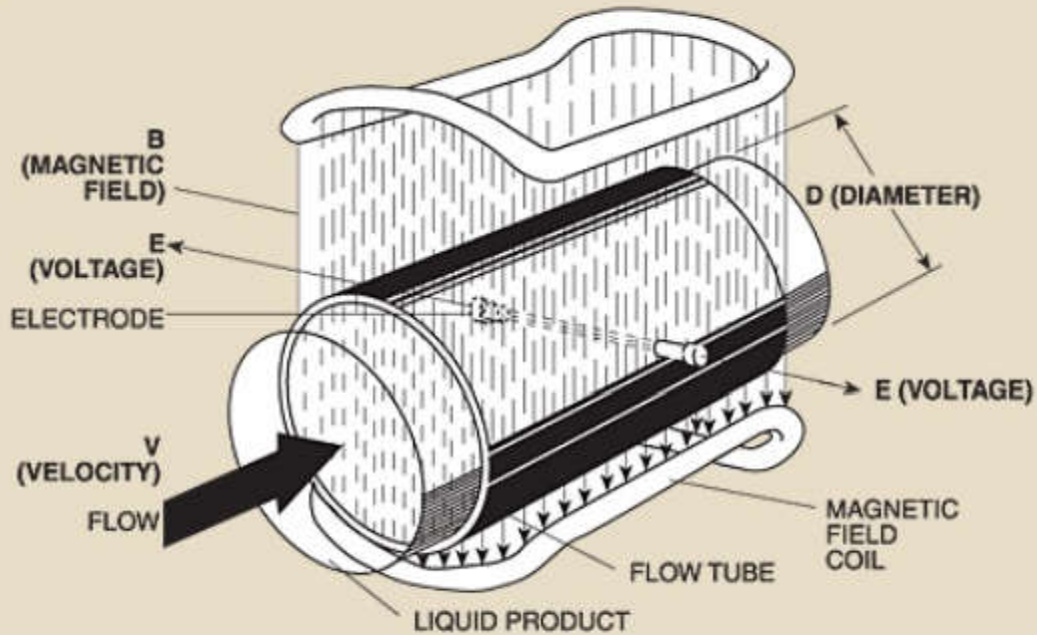

$E \propto VBD$   
 E = INDUCED VOLTAGE  
 V = AVERAGE LIQUID VELOCITY  
 B = MAGNETIC FIELD  
 D = DISTANCE BETWEEN ELECTRODES (PIPE I. D.)

# Uses...

- Pipelines...



- Refineries



# Advantages & Disadvantages

## **Advantages:**

- Minimum obstruction in the flow path yields minimum pressure drop.
- It can measure forward as well as reverse flow with equal accuracy.
- Low maintenance cost because of no moving parts.
- Corrosive or slurry fluid flow.

## **Disadvantage:**

- Requires electrical conductivity of fluid.
- Zero check can only be done when there is no flow.



# PH MEASUREMENT



# pH:-

- The solution of alkalinity or acidity of aqueous solution is determined by the relative concentration of hydrogen and hydroxyl ions in solution.
- Solution is acidic when hydrogen ions are in majority and alkaline when hydroxyl ions are in majority .
- Hydrogen ion concentration is measured on a scale known as pH scale
- $$\text{pH} = -\log_{10}(\text{H}^+)$$

# ELECTRICAL METHOD OF PH MEASUREMENT

- This method is based upon the measurement of electrical potential.

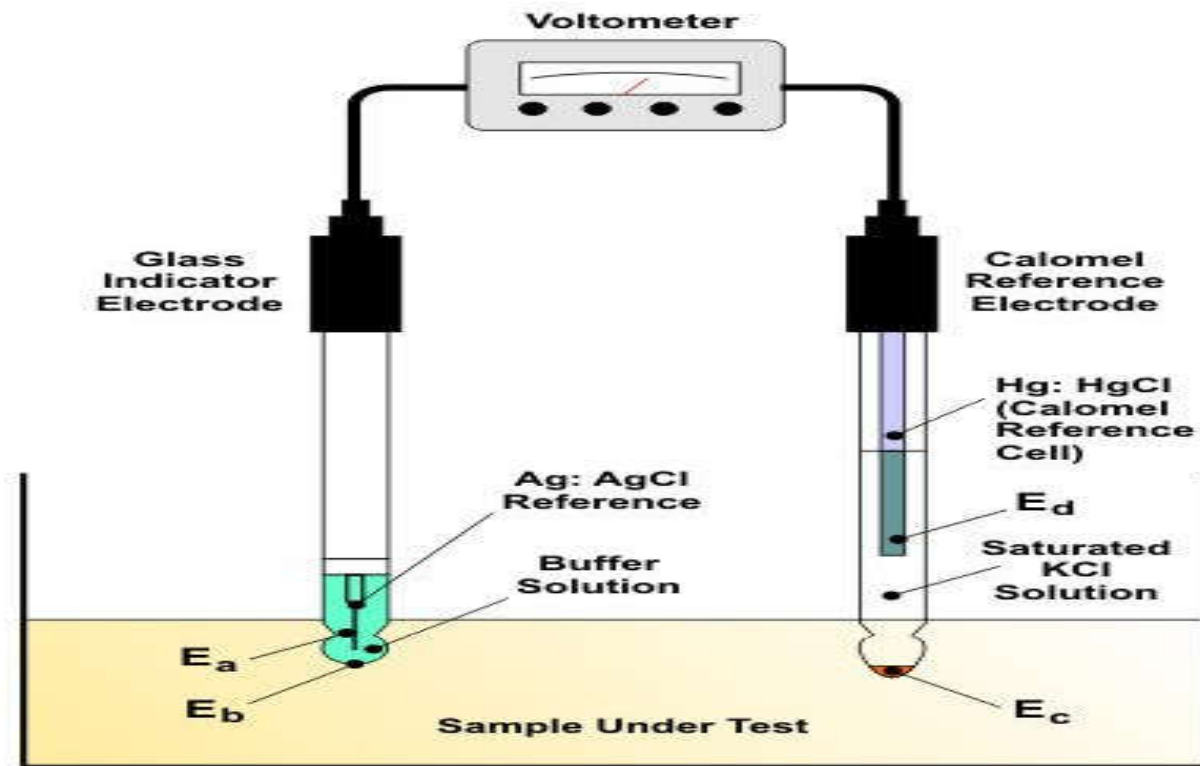

# Theory of ELECTRICAL METHOD

- In this method Electrode is immersed in the solution .An electric potential is produced at the Electrode which forms an electrolytic half cell.
- This is a measuring cell. A second electrode is required to provide the a standard potential and to complete the cell. This is the reference cell.
- The algebraic sum of the potential of the two half cells is proportional to the concentration of the hydrogen ion activity in water based solution, indicating its acidity or alkalinity expressed as pH.

# ELECTRONIC METHOD OF PH MEASUREMENT

- In this type, pH value is read on a digital meter or indicating type meter.

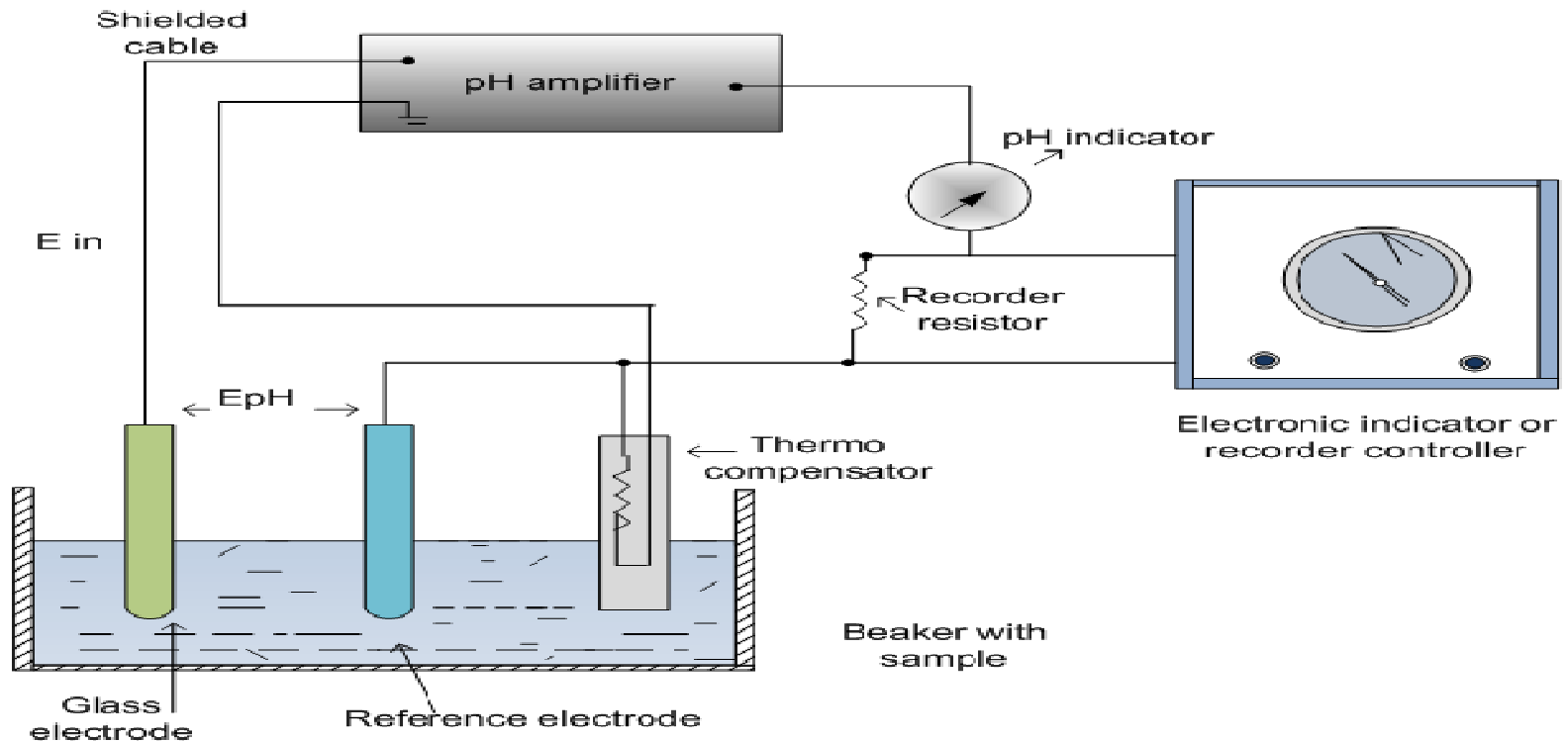

**Circuit for electronic pH measurement**

# Theory of ELECTRONIC METHOD

- In this method there are two electrodes, one as a Reference electrode and other is measuring electrode.
- The voltage difference between two is depend on the pH value of solution . the output voltage obtained here is not linear and is of very low value.
- A pH amplifier is used to amplify and line arise this voltage.
- The output of the amplifier can be sent to any indicating instrument or can be sent to recorder or to computer for storage

# Pressure measurement

## PRESSURE MEASUREMENT

Pressure is the action of one force against another over, a surface. The pressure  $P$  of a force  $F$  distributed over an area  $A$  is defined as:  $[ P = F/A ]$

Units of pressure: standard:  $N/m^2$  (Pa-Pascal),  
Kpa (Kilo Pascal)  $1\text{Bar}=100\text{kpa}$

## SENSING ELEMENTS

The main types of sensing elements are • Bourdon tubes • diaphragms • bellows . The basic pressure of sensing element can be configured as a C-shaped Bourdon tube (A); a helical Bourdon tube (B); flat diaphragm (C); a convoluted diaphragm (D); a capsule (E); or a set of bellows (F).

# SENSING ELEMENTS

The main types of sensing elements are

- Bourdon tubes
- diaphragms
- bellows

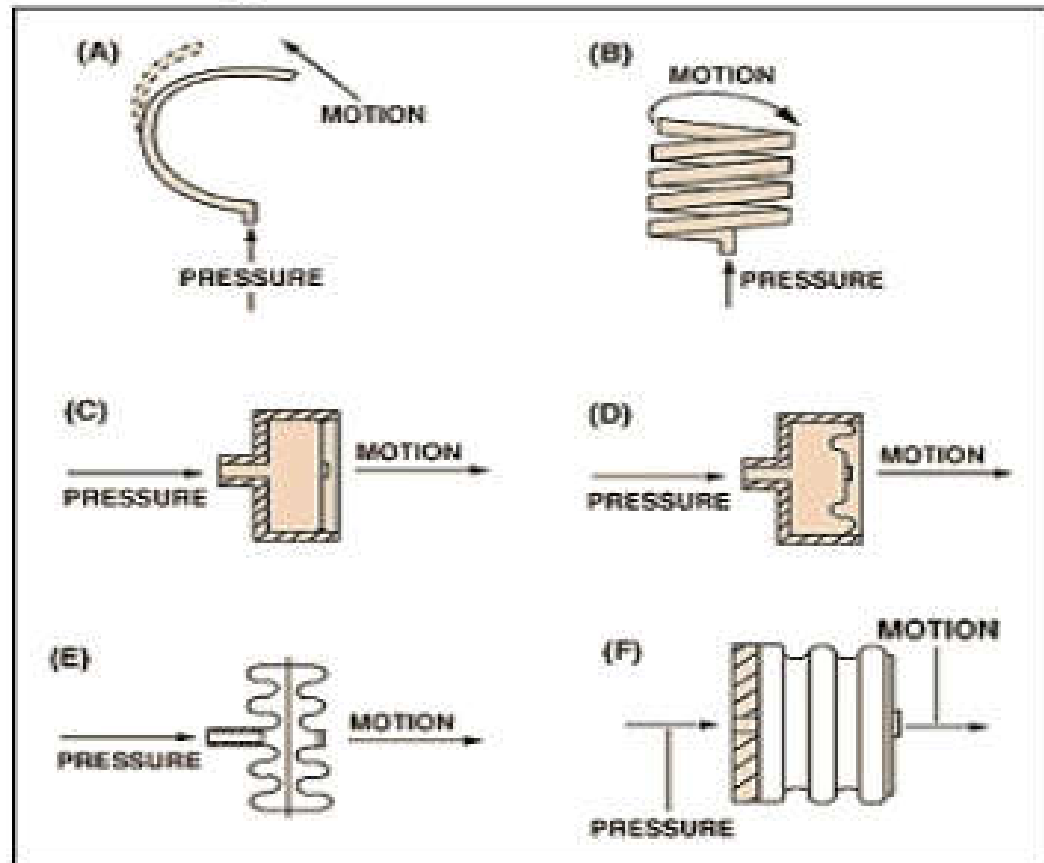

The basic pressure sensing element can be configured as a C-shaped Bourdon tube (A); a helical Bourdon tube (B); flat diaphragm (C); a convoluted diaphragm (D); a capsule (E); or a set of bellows (F).



# Pressure Measurements

## Bellows

- BELLOWS •
- Bellows sensor is an axially flexible, cylindrical enclosure with folded sides. When pressure is applied through an opening, the closed end extends axially.
- Bellows elements can measure absolute pressure, gauge pressure, vacuum, or differential pressure.

## Bourdon Tube

- BOURDONTUBE •
- A Bourdon gauge uses a coiled tube, which, as it expands due to pressure increase causes a rotation of an arm connected to the tube.
- bourdon are often used in harsh environments and high pressures, but can also be used for very low pressures; the response time however, is slower than the bellows or diaphragm.
- C-type bourdon psi Range as low as 0 - 15 psi up to 0-1500
- Helical bourdon Range as low as 0 - 200 psi up to 0 - 6000 psi
- Spiral bourdon Range as low as 0-10 psi up to 0-100,000 psi.

# BELLOWS

- bellows sensor is an axially flexible, cylindrical enclosure with folded sides. When pressure is applied through an opening, the closed end extends axially.
- Bellows elements can measure absolute pressure, gauge pressure, vacuum, or differential pressure.

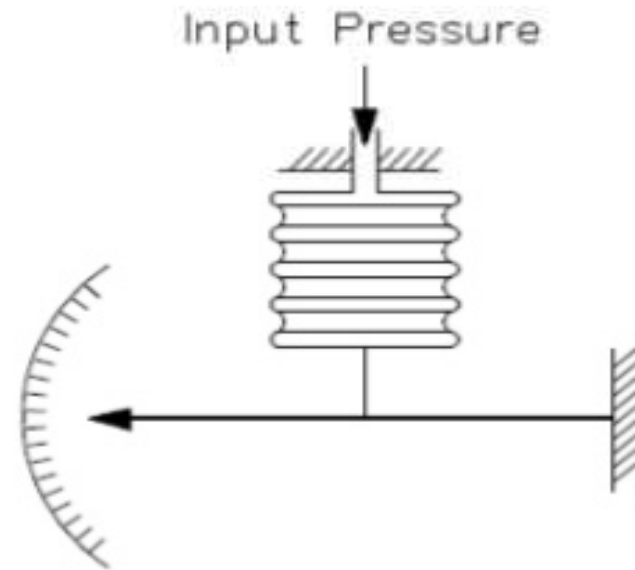
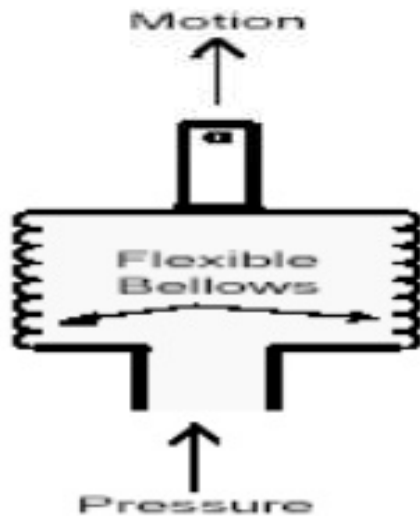

## BOURDON TUBE

- A Bourdon gauge uses a coiled tube, which, as it expands due to pressure increase causes a rotation of an arm connected to the tube.
- Bourdon gauges are often used in harsh environments and high pressures, but can also be used for very low pressures; the response time however, is slower than the bellows or diaphragm.

### C-type bourdon

psi Range as low as 0 - 15 psi up to 0-1500

### Helical bourdon

Range as low as 0 - 200 psi up to 0 - 6000 psi

### Spiral bourdon

Range as low as 0-10 psi up to 0-100,000 psi

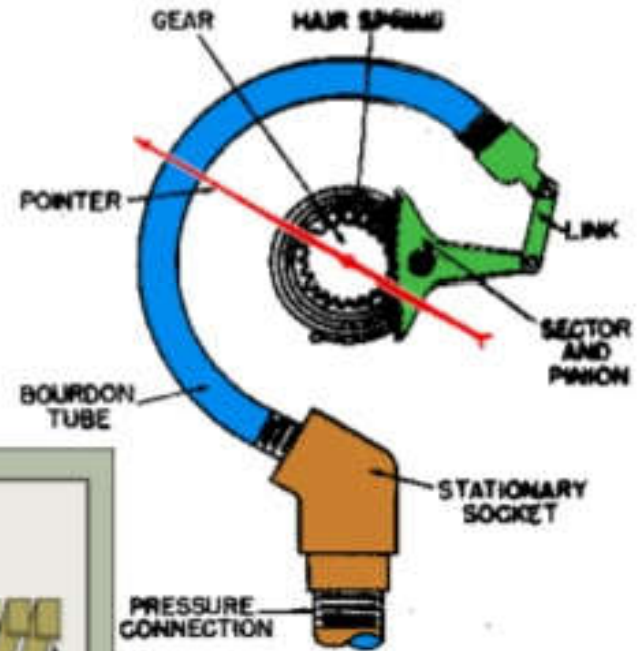
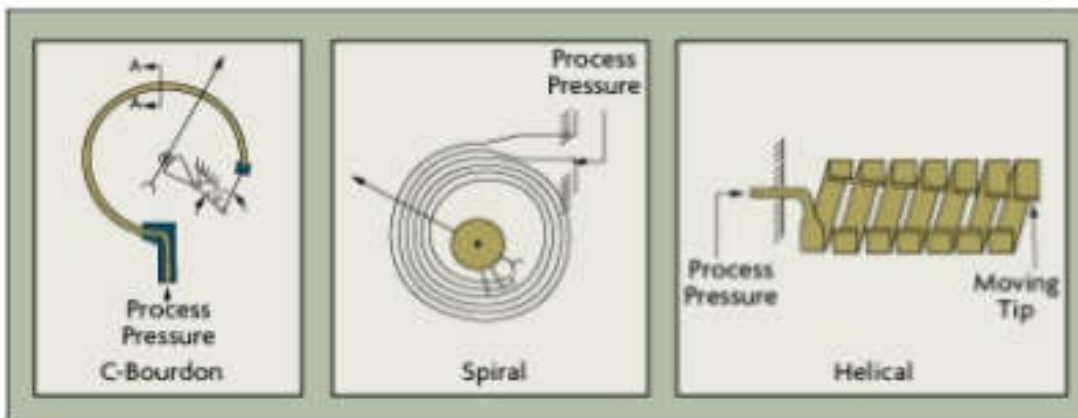

# Bourdon tube pressure gauge

- Principle:- The bourdon tube works on a simple principle that a bent tube will change its shape .
- As pressure is applied internally, the tube straightens and returns to its original form when the pressure is released .
- The tip of the tube moves with the internal pressure change and is easily converted with a pointer onto a scale.

# Diaphragm

- A diaphragm is a circular-shaped convoluted membrane that is attached to the pressure fixture around the circumference . The pressure medium is on one side and the indication medium is on the other.
- Diaphragms provide fast acting and accurate pressure indication. However, the movement or stroke is not as large as the bellows .

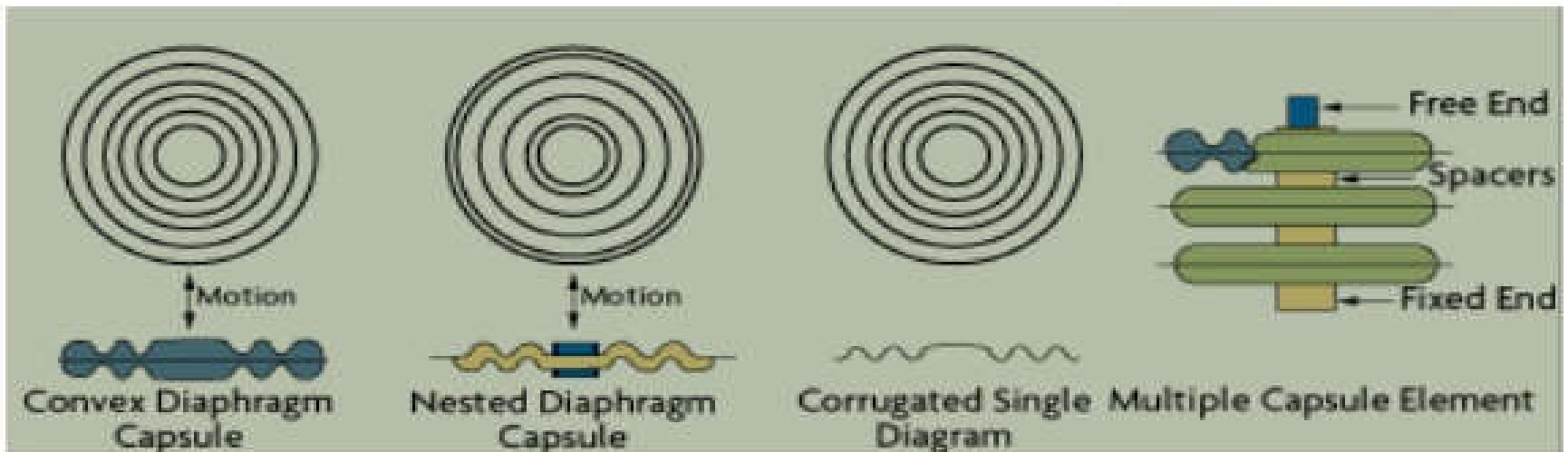
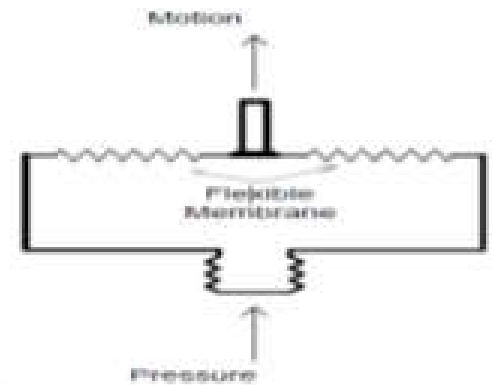

# Diaphragm Gauge of pressure measurements

- The diaphragm is a flexible disc, which can be either flat or with concentric corrugations and is made from sheet metal with high tolerance dimensions.
- The diaphragm can be used as a means of isolating the process fluids, or for high pressure applications.
- It is also useful in providing pressure measurement with electrical transducers (LVDT).
- It is used as primary pressure transducers in many dynamic pressure measuring devices.



## Diaphragm

- There are two different devices that are referred to as capsule.
- The first is shown in figure . The pressure is applied to the inside of the capsule and if it is fixed only at the air inlet it can expand like a balloon. This arrangement is not much different from the diaphragm except that it expands both ways.
- The capsule consists of two circular shaped, convoluted membranes (usually stainless steel) sealed tight around the circumference. The pressure acts on the inside of the capsule and the generated stroke movement is shown by the direction of the arrow.
- The second type of capsule is like the one shown in the differential pressure transmitter (DP transmitter). The capsule in the bottom is constructed with two diaphragms forming an outer case and the interspace is filled with viscous oil. Pressure is applied to both side of the diaphragm and it will deflect towards the lower pressure.

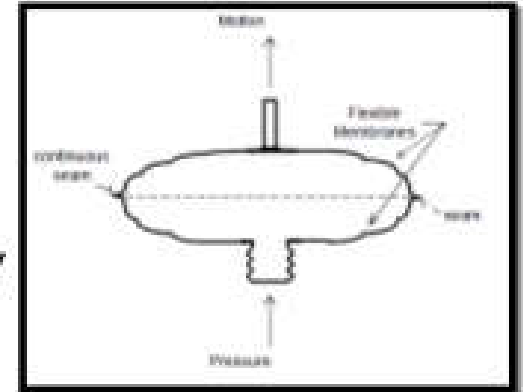

# Temperature Measurement





# Introduction

- ✓ The accurate measurement of temperature is vital across a broad spectrum of human activities,
    - ❖ Including industrial processes (e.g. making steel) Manufacturing;
    - ❖ Monitoring (in food transport and storage),
    - ❖ Health and safety.
  - ✓ In fact, in almost every sector, temperature is one of the key parameters to be measured
- 



- ❖ The means of accurately measuring temperatures has long fascinated people.
- ❖ One of the differences between temperature and other physical concepts, **such as mass or length**, is that it is **subjective**.
- ❖ Different people will have different perceptions of **what is hot and what is cold**.
- ❖ To make **objective measurements**, we must use **thermometer** in which some **physical property** of a substance changes with temperature in a reliable and reproducible way.



## Scale

❖ Temperature is a measure of the **thermal energy** in the body.  
Normally measured in **degrees [°]** using one of the following scales.

1. **Fahrenheit.** [°F]
2. **Celsius or centigrade.** [°C]
3. **Kelvin .** [°K]



## 2. Bimetallic Thermometer

- ❖ In an industry, there is always a need to **measure and monitor temperature of a particular spot, field or locality.**
- ❖ The industrial names given to such temperature sensors are **Temperature Indicators (TI)** or **Temperature Gauges (TG).**
- ❖ All these temperature gauges belong to the class of instruments that are known as **bimetallic sensors.**



# Bimetallic Thermometer

Two basic principles of operation is to be followed in the case of a bimetallic sensor.

1) A metal tends to undergo a volumetric dimensional change (expansion/contraction), according to the change in temperature.

2) Different metals have different coefficient of temperatures. The rate of volumetric change depends on this coefficient of temperature.

- The device consists of a **bimetallic strip** of two different metals .
- They are bonded together to form a **spiral or a twisted helix**.
- Both these metals are joined together at one end by either **welding or riveting**.
- It is bonded so strong that there will not be any relative motion **between the two**.
- The image of a bimetallic strip is shown below.

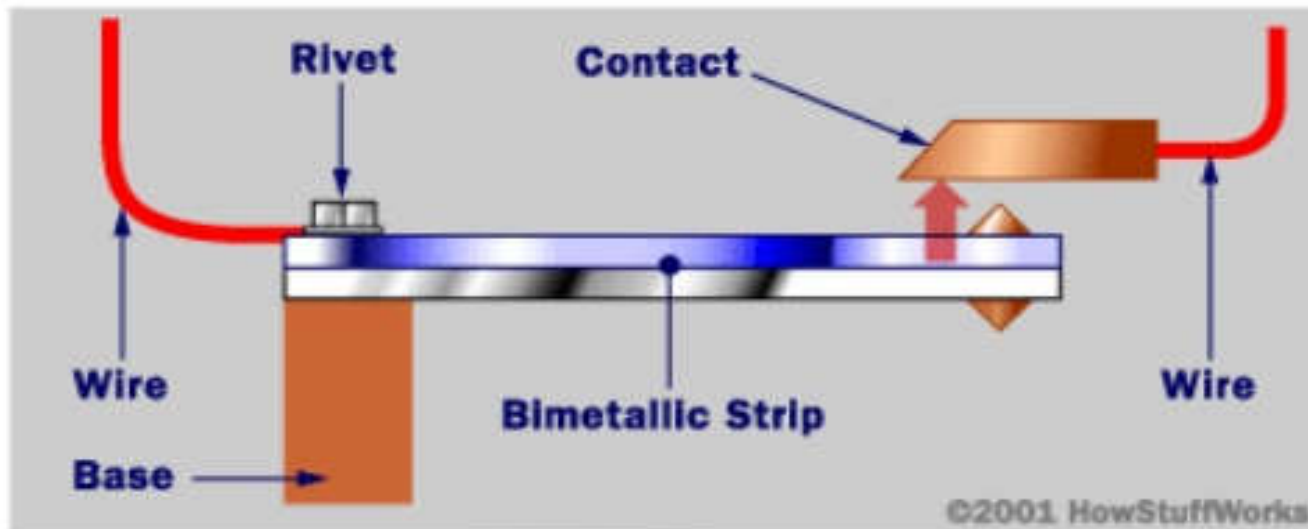





## Resistance Temperature Detector (RTD)

RTD can also be called a resistance thermometer as the **temperature measurement** will be a measure of the **output resistance**.

The main **principle** of operation of an RTD is that when the **temperature** of an object **increases or decreases**, the **resistance** also **increases or decreases** proportionally.

ie. **positive temperature coefficient**

## **Resistance Thermometers**

It is well known that resistance of metallic conductors increases with temperature, while that of semiconductors generally decreases with temperature. Resistance thermometers employing metallic conductors for temperature measurement are called Resistance Temperature Detector (RTD), and those employing semiconductors are termed as Thermistors. RTDs are more rugged and have more or less linear characteristics over a wide temperature range. On the other hand Thermistors have high temperature sensitivity, but nonlinear characteristics.



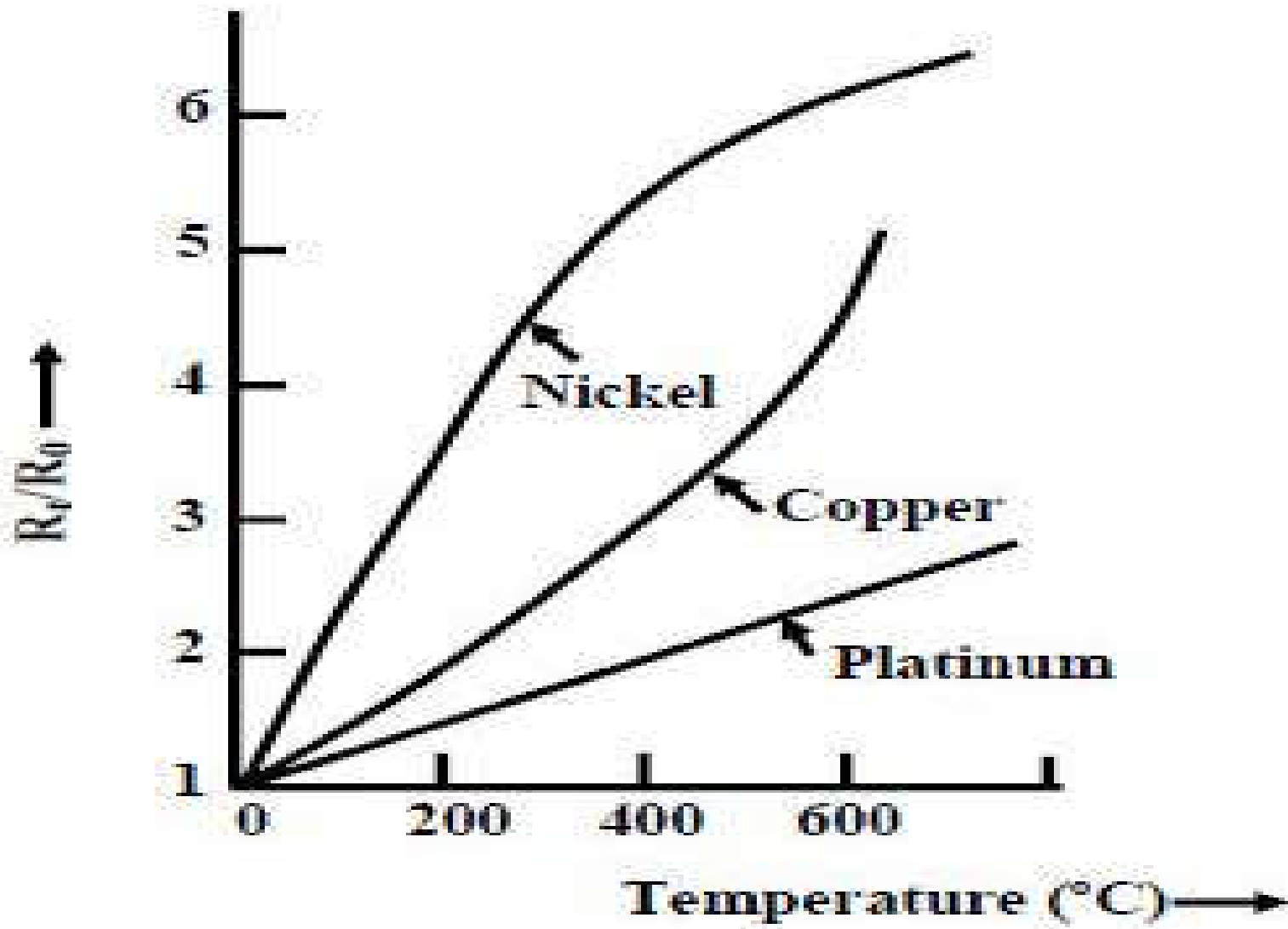



## RTD Types

RTD types are broadly classified according to the different **sensing elements used**.

Platinum, Nickel and Copper are the most commonly used sensing elements.

# Resistance Temperature Detector (RTD)

## Resistance Temperature Detector-(RTD)-2 Wire

**Copper lead** wires are satisfactory for all the arrangements.  
For a given RTD, all the lead-wires should be of the **same gauge** and the **same length**, and should be run in the same conduit.

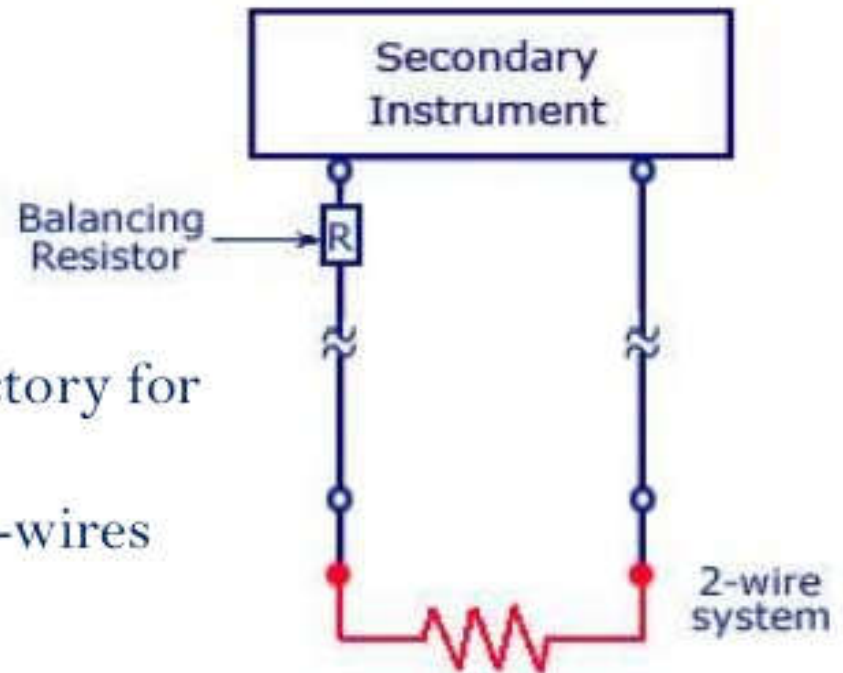



- **Advantages**

1. Very high accuracy
2. Excellent stability and reproducibility
3. Interchangeability
4. Ability to be matched to close tolerances for temperature difference measurements.
5. Ability to measure narrow spans
6. Suitability for remote measurement





- **Disadvantages**

1. Susceptibility to mechanical damage
2. Need for lead wire resistance compensation
3. Sometimes expensive
4. Susceptibility to self-heating error
5. Susceptibility to signal noise
6. Unsuitability for bare use in electrically conducting substance
7. Generally not repairable
8. Need for power supply

# Thermistor



Thermistors are semiconductor type resistance thermometers. They have very high sensitivity but highly nonlinear characteristics. This can be understood from the fact that for a typical  $2000\ \Omega$  the resistance change at 25 degree Celsius is  $80\ \Omega$  per degree Celsius, whereas for a  $2000\ \Omega$  platinum RTD the change in resistance at 25 degree Celsius is  $7\ \Omega$  per degree Celsius. Thermistors can be of two types: (a) Negative temperature coefficient (NTC) thermistors and (b) Positive temperature co-efficient (PTC) thermistors. Their resistance-temperature characteristics are shown in fig. . The NTC thermistors, whose characteristics are shown in fig. is more common.

# NTC characteristics of thermistor

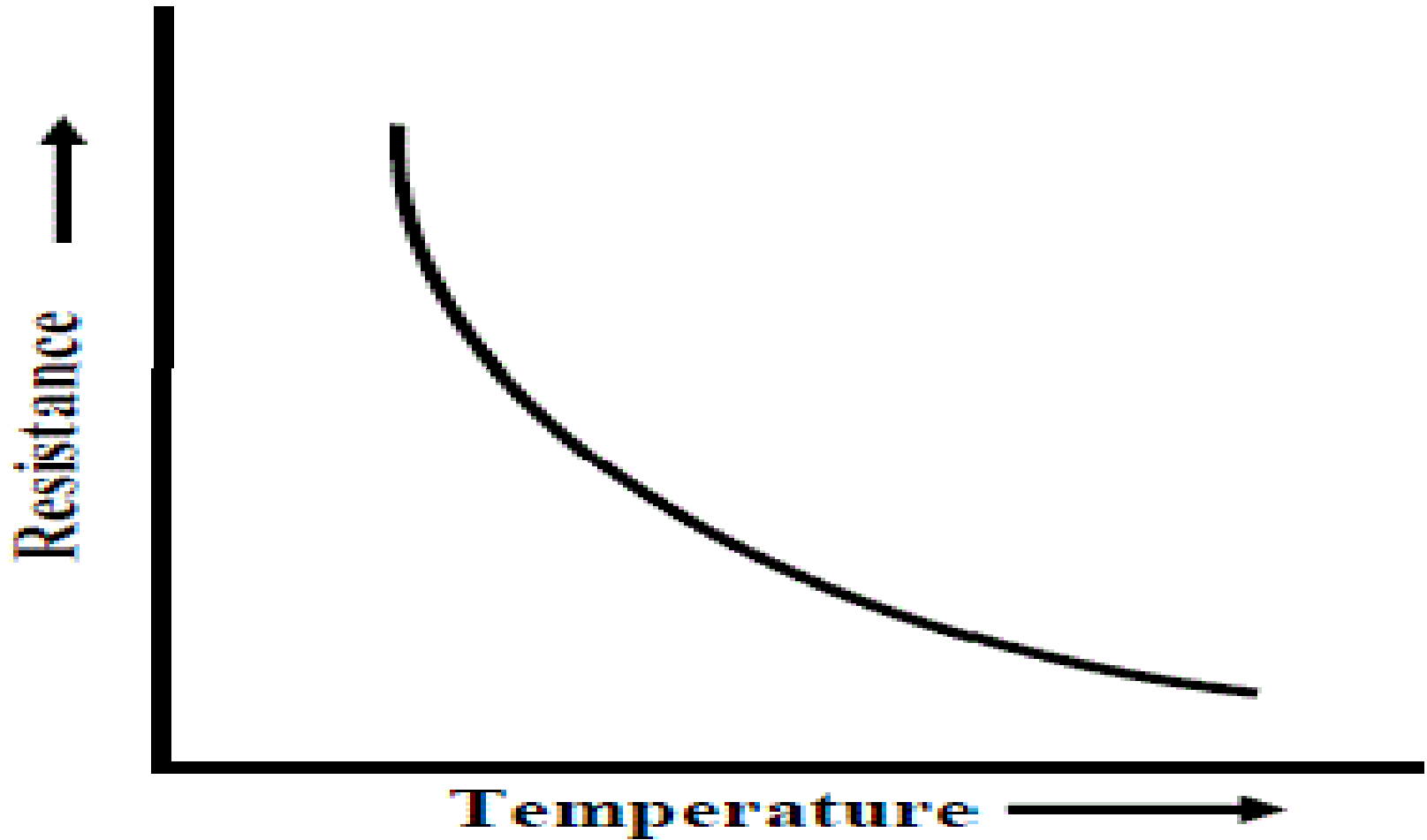

# PTC characteristics of thermistor

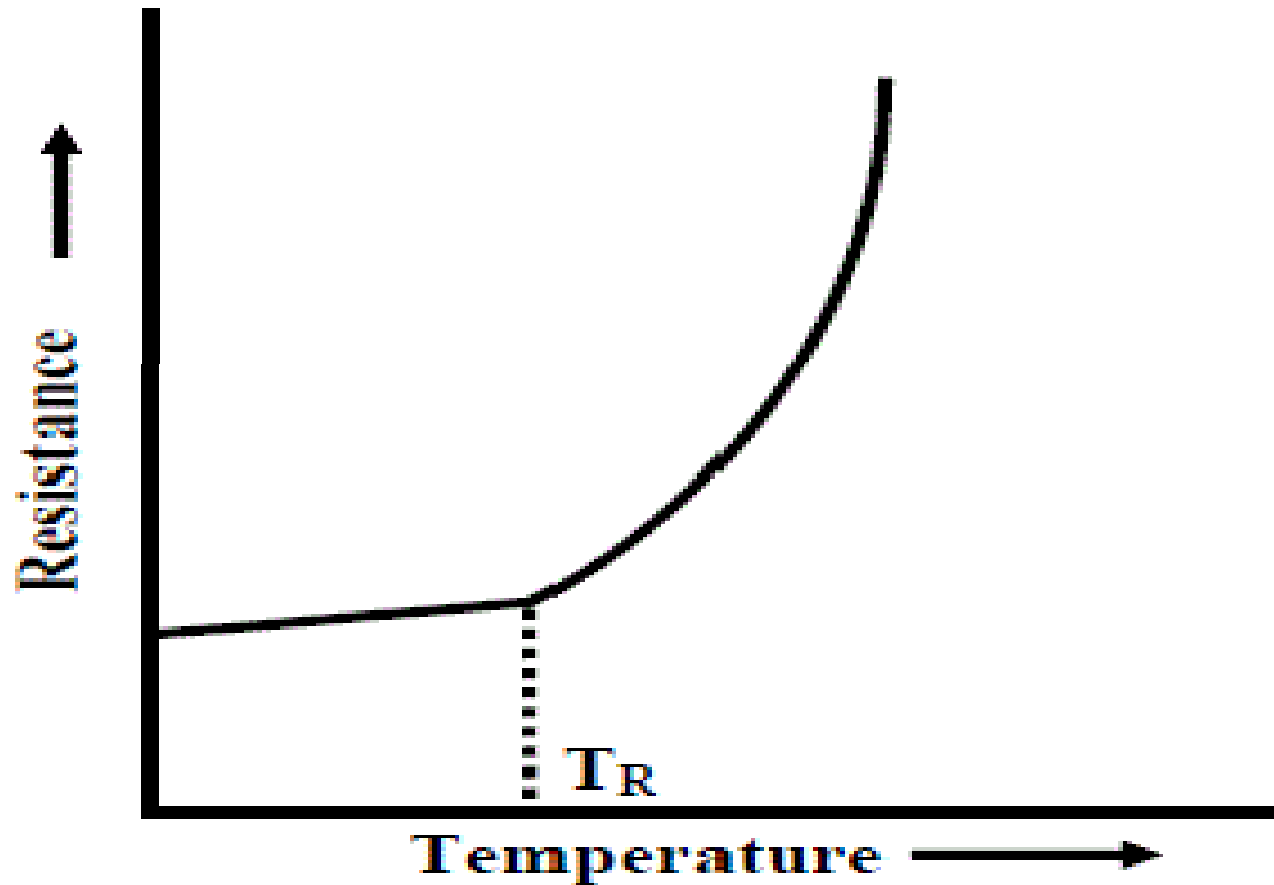







## Pyrometer

- A **pyrometer** is a device that is used for the **temperature measurement** of an object.
- The device actually **tracks and measures** the amount of heat that is radiated from an object.
- The thermal heat radiates from the object to the optical system present inside the pyrometer.
- The optical system makes the thermal radiation into a better focus and passes it to the detector.

- 
- In an **optical pyrometer**, a **brightness comparison** is made to measure the temperature.
  - The device compares the brightness produced by the radiation of the object whose temperature is to be measured,
  - For an object, its **light intensity** always depends on the temperature of the object.
  - After **adjusting** the temperature, the **current passing** through it is measured using a multimeter, as its value will be proportional to the temperature of the source when calibrated.
  - The working of an optical pyrometer is shown in the figure below.
- 

0000 0000  
00000  
00000  
00  
00

### Optical Pyrometer

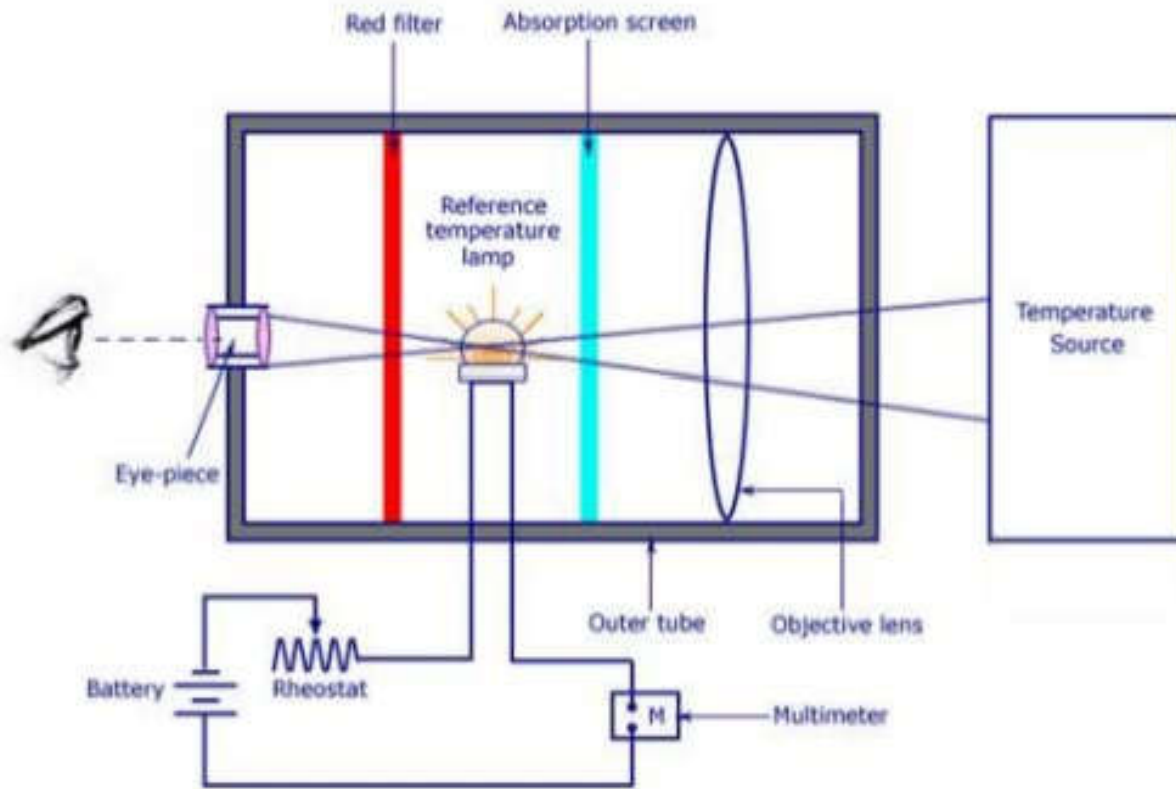

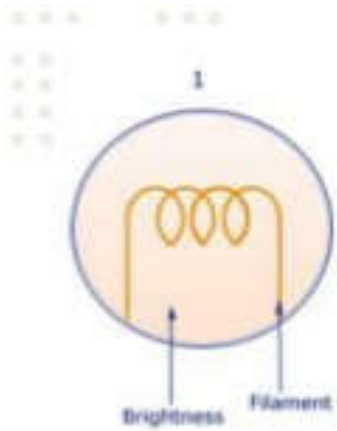

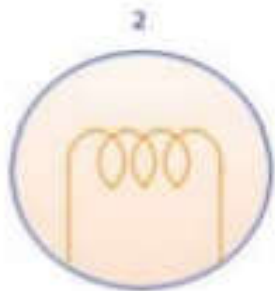

The filament is dark. That is, cooler than the temperature source.

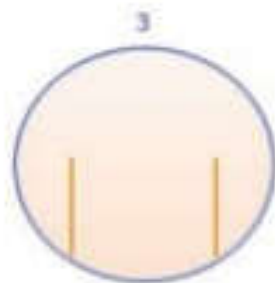

Filament is bright. That is, hotter than the temperature source.



Filament disappears. Thus, there is equal brightness between the filament and temperature source



➤ As shown in the figure above, an optical pyrometer has the following components.

1. An **eye piece** at the left side and an optical lens on the right.
  2. A **reference lamp**, which is powered with the help of a battery.
  3. A **rheostat** to change the current and hence the brightness intensity.
  4. So as to increase the temperature range which is to be measured, an absorption screen is fitted between the optical lens and the reference bulb.
- 





## Working

1. The **radiation** from **the source is emitted** and the optical objective lens captures it.
2. The lens helps in focusing the **thermal radiation** on to the reference bulb.
3. The observer watches the process through the eye piece and corrects it in such a manner that the reference lamp filament has a sharp focus and the filament is super-imposed on the temperature source image.
4. The observer starts changing the **rheostat** values and the current in the reference lamp changes.
5. This in turn, changes its intensity.

This change in current can be observed in three different ways.





At this time, the current that flows in the reference lamp is measured, as its value is a measure of the temperature of the radiated light in the temperature source, when calibrated.





- **Advantages**

1. Provides a very high accuracy with  $\pm 5^{\circ}$  Celsius.
2. The biggest advantage of this device is that, there is no direct contact between the pyrometer and the object whose temperature is to be found out.

- **Disadvantages**

1. As the measurement is based on the light intensity, the device can be used only in applications with a minimum temperature of  $700^{\circ}$  Celsius.
  2. The device is not useful for obtaining continuous values of temperatures at small intervals.
- 